



---

## Stoves with Touch Remote

Vittoria V - Atena V  
RV 120 Touch



**SAVE THESE INSTRUCTIONS**

**Please read this entire manual before installation and use of this pellet fuel-burning room heater. Failure to follow these instructions could result in property damage, bodily injury or even death. Contact local building or fire officials about restrictions and installation inspection requirements in your area. Contact local authorities to see if a permit must be obtained before installation.**

## SUMMARY

<b>INTRODUCTION .....</b>	<b>4</b>
<i>Information.....</i>	<i>4</i>
<i>Description of use and maintenance manual.....</i>	<i>4</i>
<b>WARNINGS .....</b>	<b>4</b>
<b>THANK YOU.....</b>	<b>4</b>
<b>SAFETY INFORMATION.....</b>	<b>5</b>
<b>GENERAL.....</b>	<b>6</b>
<i>Responsibility.....</i>	<i>6</i>
<i>Majolica finishes .....</i>	<i>6</i>
<i>What are the wood pellets .....</i>	<i>7</i>
<i>The components of the stove.....</i>	<i>7</i>
<i>The combustion.....</i>	<i>8</i>
<i>Compliance status.....</i>	<i>9</i>
<i>Spare parts.....</i>	<i>9</i>
<i>Glass and gasket replacement.....</i>	<i>9</i>
<b>SAFETY DEVICES .....</b>	<b>10</b>
<b>TECHNICAL FEATURES.....</b>	<b>10</b>
<i>Automatic cleaning system.....</i>	<i>10</i>
<b>POSITIONING, ASSEMBLY AND INSTALLATION .....</b>	<b>11</b>
<i>Environment of use .....</i>	<i>11</i>
<i>Mobile Home Requirements .....</i>	<i>12</i>
<i>Vent Termination Locations .....</i>	<i>12</i>
<i>Examples of installation .....</i>	<i>13</i>
<i>Determining Size of Pipe to install.....</i>	<i>14</i>
<i>Minimum distance from combustibile material .....</i>	<i>15</i>
<i>Standard horizontal installation configurations.....</i>	<i>16</i>
<b>CONTROLS AND USE.....</b>	<b>18</b>
<i>Control panel description.....</i>	<i>18</i>
<i>Radio touch remote control initialization .....</i>	<i>18</i>
<i>Description of the radio touch remote control .....</i>	<i>19</i>
<i>Description of the display .....</i>	<i>19</i>
<i>Time and date setting .....</i>	<i>20</i>
<b>PROCEDURES FOR USE .....</b>	<b>21</b>
<i>Checks prior to start-up .....</i>	<i>21</i>
<i>Auger loading .....</i>	<i>21</i>
<i>Switching the appliance on and off.....</i>	<i>21</i>
<i>Failed ignition .....</i>	<i>22</i>
<i>Setting operating temperature and power: .....</i>	<i>22</i>
<b>OPERATING PHASES OF THE APPLIANCE.....</b>	<b>22</b>
<i>Sequence of ignition phases .....</i>	<i>22</i>
<i>Modulation .....</i>	<i>22</i>
<i>Description of menu functions .....</i>	<i>22</i>
<i>Setting .....</i>	<i>25</i>
<i>Stove phase general layout.....</i>	<i>27</i>
<i>Warning Pop -Up .....</i>	<i>28</i>
<i>Alarms (table with reference codes).....</i>	<i>28</i>
<i>Thermal alarm with reset.....</i>	<i>30</i>
<b>ELECTRICAL WIRING DIAGRAM .....</b>	<b>31</b>
<b>MAINTENANCE .....</b>	<b>32</b>
<i>Cleaning the surfaces .....</i>	<i>32</i>
<i>Cleaning the FIREX 600 .....</i>	<i>32</i>
<b>WARRANTY .....</b>	<b>33</b>
<i>Warranty conditions.....</i>	<i>33</i>
<i>Registration of warranty .....</i>	<i>33</i>
<i>Info and problems .....</i>	<i>33</i>

## INTRODUCTION



Please read this manual carefully. It describes all the phases necessary for perfect functioning of the stove.



The regulations on installation and operation in this manual may differ from the regulations in force locally. In this case, the indications of the competent local authorities must always be followed. The drawings shown in this manual are indicative and not to scale.

### **Information**

The packaging that we have used offers good protection against any damage due to transport. Always check the stove immediately after delivery: in the event of any damage, please inform your Ravelli dealer immediately.

### **Description of use and maintenance manual**

With this use and maintenance manual, Ravelli wishes to provide the user with all the information on safety in using the stove, in order to avoid damage to persons or things or parts of the stove. Please read this manual carefully before use and any work on the product.

## WARNINGS

Ravelli stoves are manufactured taking care even on the individual components in order to protect both the user and the installer from any accidents.

The authorized personnel, after any work on the product, should therefore always pay special attention to the electrical connections.

Installation must be performed by authorized personnel, who must give the purchaser a declaration of conformity of the appliance, and who will assume all responsibility for the final installation and consequent good functioning of the product installed. It is also necessary to take into consideration all the laws and national, regional, provincial and local regulations present in the country in which the appliance has been installed. In the event of failure to respect these precautions, Aico S.p.A. declines all responsibility.

This instruction manual is an integral part of the product: please make sure that it is always with the stove, including in the case of transfer to another owner or user, or transfer to another place. In the case of its damage or loss, please request another copy from the Technical service.

This stove must be used for the purpose for which it has been specifically manufactured. Do not use the appliance as an incinerator or in any way other than that for which it was designed. All contractual and tort responsibility of the manufacturer is excluded for damage caused to persons, animals or things, due to errors of installation, maintenance regulation or improper use. No other fuel except the pellets must be used. Do not use liquid fuels.

After having removed the packaging, please make sure that the contents are complete and intact.

All the electrical components that make up the stove must be replaced with original spare parts exclusively from an authorized technical assistance centre.

Maintenance of the stove must be performed at least once a year, planning it in time with the technical assistance centre.

Do not make any unauthorized modification to the appliance.

For safety reasons, please remember that:

- the stove must not be used by children or disabled people without assistance;
- do not touch the stove when barefoot or when any parts of the body are wet;
- the safety devices or adjustment devices must not be modified without the authorization or instructions of Ravelli.

The stove, especially the external surfaces, reaches very high temperatures when it is in operation; take care when touching it to avoid burns.

The stove has been designed to function in any climatic condition; in the event of particularly adverse conditions (wind, freezing), safety systems could switch off the stove.

If this occurs, contact the technical assistance and, in any case, do not disable the safety systems.

## THANK YOU

Dear Customer,

We would like to thank you and congratulate you on the excellent choice you have made.

With the Ravelli stove, you will see that quality and economy can go hand in hand, offering excellent performances with limited consumption and being totally practical. Please find below some suggestions, which we would like to give you, to obtain the most from your stove and to fully enjoy all the advantages that it can give you.

Through this, we want to be close to our customers to offer the maximum technical support to all those who use our technology.

Aico S.p.A. thanks you for your confidence and wishes you happy times in the company of your pellet stove.

## **SAFETY INFORMATION**

The stove must be installed and tested by specialized personnel instructed by the Ravelli. Please read this use and maintenance manual before installing and putting the stove into operation!

If you require further information, please contact your Ravelli dealer.

### **IMPORTANT**

The place of installation of the stove must comply with local, national and Federal regulations.

The stove must be fuelled only with quality pellets with a diameter of 6 mm as described in the specific chapter.

The stove cannot operate with traditional wood

The stove must not be used as an incinerator. **FIRE HAZARD!!!**

Installation, the electrical connections, checking the functioning and maintenance must be performed by qualified and authorized personnel.

Improper installation or poor maintenance (not compliant with what is shown in the following manual) may cause damage to persons and things. In this condition, Ravelli is relieved of all civil or criminal responsibility.

Before connecting the stove electrically, the connection of the exhaust tubes must be completed (specifically for pellet stoves, not made from aluminium) with the flue.

The protection grille inside the pellet hopper must never be removed.

There must be sufficient circulation of air in the room where the stove is installed.

Never open the door of the stove whilst it is functioning. **FIRE HAZARD!!!**

The stove must not be used with the door open or with the glass broken. **FIRE HAZARD!!!**

When the stove is operating, the surfaces, the glass, the handle and the pipes become overheated: during functioning, these parts must only be touched with the adequate protection.

Do not light the stove without having first performed the daily inspection as described in the MAINTENANCE chapter of this manual.

Do not place any washing on the stove to dry. Keep clothes and similar at a suitable distance from the stove. **FIRE HAZARD!!!**  
**DO NOT USE CHEMICALS OR FLUIDS TO START THE FIRE.**

**DO NOT BURN GARBAGE OR FLAMMABLE FLUIDS SUCH AS GASOLINE, NAPHTHA OR ENGINE OIL.**

**DO NOT INSTALL A FLUE DAMPER.**

**DO NOT CONNECT THIS UNIT TO A CHIMNEY FLUE SERVING ANOTHER APPLIANCE.**

Attachment and securement of the exhaust venting system to the product and to each adjoining section. All joints for connector pipe shall be required to be fastened with at least three screws. If vented horizontally, joints shall be made gaslight in a manner that shall be specified.

Perform regular inspection, maintenance, and cleaning of the chimney and chimney connector

Disposal of Ashes: Ashes should be placed in a metal container with a tight fitting lid. The closed container of ashes should be placed on a non-combustible floor or on the ground, well away from all combustible materials, and moved outdoors immediately. If the ashes are disposed of by burial in soil or otherwise locally dispersed, they should be retained in the closed container until all cinders have thoroughly cooled. Other waste shall not be placed in this container.

Caution against the storage or use of flammable liquids, as follows: Never use gasoline, gasoline-type lantern fuel, kerosene, charcoal lighter fluid, or similar liquids to start or 'freshen up' a fire in this heater. Keep all such liquids well away from the heater while it is in use.

**Creosote - Formation and Need for Removal**

When wood is burned slowly, it produces tar and other organic vapors, which combine with expelled moisture to form creosote. The creosote vapors condense in the relatively cool chimney flue of a slow-burning fire. As a result, creosote residue accumulates on the flue lining. When ignited this creosote makes an extremely hot fire

The exhaust venting system should be inspected at least once every two months during the heating season to determine if a creosote buildup has occurred.

If creosote has accumulated it should be removed to reduce the risk of a chimney fire.

Scrupulously follow the maintenance programme.

Do not switch off the stove by disconnecting the electricity mains supply.

Do not clean the stove until the structure and the ashes have cooled down completely.

Carry out all operations in maximum safety and tranquillity.

Coply with exhaust venting system termination requirements including location restrictions to air inlets, distances from windows, doors, and air inlets and distance to combustible materials.

**DO NOT CONNECT TO OR USE IN CONJUNCTION WITH ANY AIR DISTRIBUTION DUCTWORK UNLESS SPECIFICALLY APPROVED FOR SUCH INSTALLATIONS.**

Hot while in operation. Keep children, clothing and furniture away. Contact may cause skin burns.

The type of chimney shall be suitable for solid fuel and the chimney connector must be in good condition and kept clean.

Establish a routine for the fuel, pellet burner and fring technique. Check daily for creosote build-up until experience shows how often you need to clean to be safe. Be aware that the hotter the fire the less creosote is deposited and weekly cleaning may be necessary in mild weather even though monthly cleaning may be enough in the coldest months. Contact your local or fire authority for information on how to handle a chimney fire. Have a clearly understood plan to handle a chimney fire. Keep firing and deashing doors closed and maintain all seals in good conditions.

Do not strike or slam shut the door, the glass can brake. The glass shall be cleaned only when cold, do not clean a hot glass.

Use a dry cloth with normal glass detergent, do not use any abrasive cleaner.

The type of chimney shall be suitable for solid fuel and the chimney connector must be in good condition and kept clean.

When this room heater is not properly installed, a house fire may result. To reduce the risk of fire, follow the installation

instructions. Contact local building or fire officials about restrictions and installation inspection requirements in your area. This room heater must be connected to a chimney complying with the requirements for type L pellet vent listed to UL641 or CAN/ULC S609 or a code-approved masonry chimney with a flue liner.

This wood heater needs periodic inspection and repair for proper operation. It is against federal regulations to operate this wood heater in a manner inconsistent with operating instructions in this manual. - This wood heater has a manufacturer-set minimum low burn rate that must not be altered. It is against federal regulations to alter this setting or otherwise operate this wood heater in a manner inconsistent with operating instructions in this manual.

This heater is designed to burn wood pellet only. **DO NOT BURN ANY OTHER FUEL.** Burning other materials may result in release of toxic fumes or render the heater ineffective and cause smoke.

Do not overfire. Attempts to achieve heat output rates that exceed heater design specifications can result in permanent damage to the heater.

Flues gases contain carbon monoxide (CO), it is recommended to install smoke monitors and CO monitors for areas that are expected to generate CO. Inspect the chimney to minimize visible emissions.

**Soot and Flyash: Formation and Need for Removal**—The products of combustion will contain small particles of flyash. The flyash will collect in the exhaust venting system and restrict the flow of the flue gases. Incomplete combustion, such as occurs during startup, shutdown, or incorrect operation of the room heater will lead to some soot formation which will collect in the exhaust venting system. The exhaust venting system should be inspected at least once every year to determine if cleaning is necessary.

## GENERAL

The Stove must only operate in rooms. As it is controlled by an electronic board, combustion is completely automatic and controlled and the control unit regulates the ignition phase, 5 levels of power and the switching off phase, guaranteeing safe functioning.

Most of the ashes produced by the combustion of the pellets fall into the collection drawer.

However, always check the fire pot every day, as not all pellets have high standards of quality and could leave residue that is difficult to remove.

The glass has a special air circulation for self-cleaning. However, a slight greyish film cannot be avoided after a few hours of functioning.

As already mentioned earlier, pellets with a diameter of 6 mm must be used with the stove.

### **Responsibility**

Ravelli declines all responsibility, both civil and criminal, with the delivery of this manual, for any accidents deriving from partial or total failure to observe the instructions it contains,

Ravelli declines all responsibility deriving from the improper use of the stove, from its incorrect use by the user, by unauthorized modifications and/or repairs or from the use of spare parts which are not original.

The manufacturer declines all direct civil or criminal responsibility due to:

- poor maintenance
- failure to observe the instructions in the manual
- use not compliant with the safety instructions
- installation that is not compliant with the regulations in force in the country.
- installation by personnel who are not qualified or authorized
- modifications and repairs that are not authorized by the manufacturer
- use of spare parts that are not original
- exceptional events

### **Majolica finishes**

Due to the special hand finish of the majolica surface imperfections such as shadowing may occur. Those are details that make every majolica one of its kind. As it is a delicate material, please handle with care whilst cleaning and avoid blows as sudden breakage may occur. Please also take care when loading the hopper (Ed.'s note; tank containing the pellets) with the bag of pellets: do not place it on the stove!

### What are the wood pellets

The wood pellets are made from sawdust and wood shavings produced in joiners' shops. The material used cannot contain any foreign substance such as glue, varnish or synthetic substances.

Subjecting it to high pressure, the wood is pressed through a plate with holes and due to the high pressure the sawdust is heated activating the natural binders of the wood. Thus, the pellets keep their shape even without the addition of bonding substances. The density of the wood pellet varies according to the type of wood and can be 1.5 – twice greater than that of natural wood.

The diameter of the cylindrical rods is 6 mm and their length can vary between 10 and 40 mm.

Their real weight is greater than 650 kg/m<sup>3</sup>. Due to the low content of water (<10%) they have a high energy content.

The standards ISO 17225-2:2014 define the quality of the pellets:

Length: < 40 mm

Diameter: 6 mm approx.

Real weight: > 600 kg/m<sup>3</sup>

Lower heating value: ≥ 16,5 MJ/kg (≥ 7100 BTU/lb)

Residual humidity: < 10 %

Ashes: < 1.2 %

Specific weight: >1000 kg/m<sup>3</sup>

Do not put the bag of pellets on the ceramic parts during the loading operations.



The pellets must be transported and stored in a dry place. They swell on contact with damp, and cannot be used. They must always be protected from the damp both during transport and in storage. Do not place such fuel within the space heater installation clearances or within the space required for charging and ash removal.

### The components of the stove

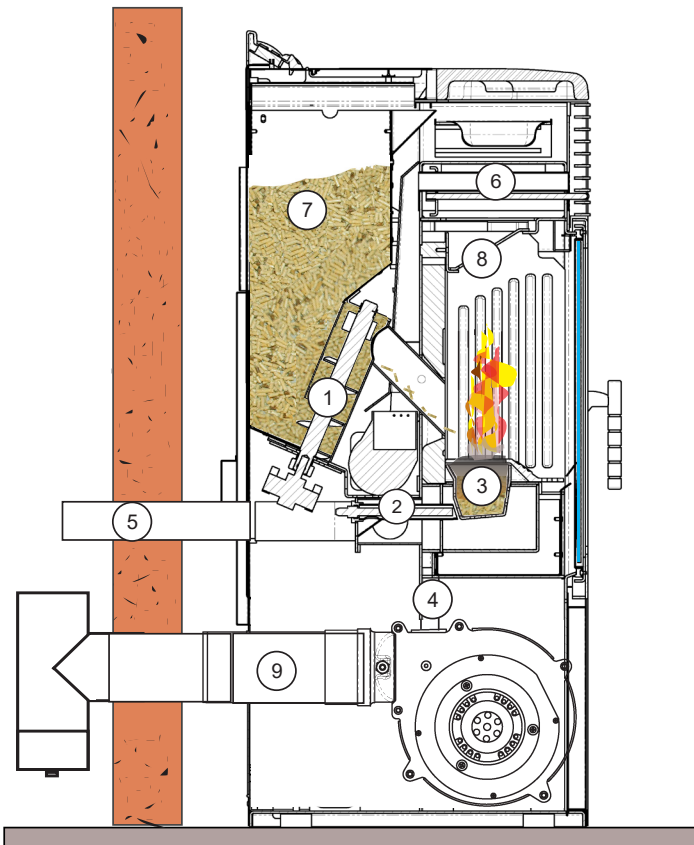

- 1) pellet loading auger
- 2) electrical igniter
- 3) combustion fire pot
- 4) tube for passage of smoke
- 5) air intake tube
- 6) stainless steel heat exchanger
- 7) pellet hopper
- 8) baffle
- 9) smoke exhaust tube

This drawing shows the internal parts of a pellet stove.

By filling the hopper (7), the pellets are loaded into the fire pot (3) through the loading auger (1).

Ignition is by means of the electrical igniter (2), which overheats the air from the special entrance (5) which on contact with the pellets will allow the development of the flame. At this point the exhaust smoke is deviated towards the stainless steel exchanger (6) and through the smoke extraction tube (4) it is released into the flue, through the connection with the smoke exhaust pipe. (9).

### The combustion

The combustion is a chemical reaction between fuel and oxidizer. The result of this reaction is the heat. The three elements that are required for the combustion are:

- Fuel (pellet)
- Oxidizer (oxygen available in the air)
- Ignition (heat of embers or electrical ignitor)

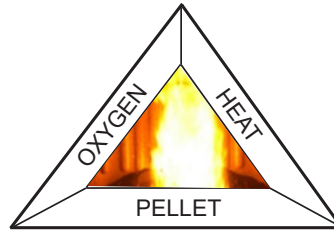

To get the combustion, the combustible and the carburant must be available in a correct proportion.

The reaction between combustible and carburant is made by an external starter. The start can be made by the hot reaction or by a sparkle.

The combustion is NOT CORRECT, the flame is too tight with too much incandescent pellet in the fire pot.

Adjust the Set pellet/air reducing the air percentage (from 0 up to -5); in the vent this is not enough to get a proper flame, increase the loading quantity of the pellet (from 0 up to +5) to reach the flame condition shown in picture 3.



**Pic. 1**

INCORRECT combustion, flame too drawn, in "blowtorch" style with a high quantity of incandescent pellets coming out of the grate. Correct the pellet/air set by reducing the percentage of air (from 0 to -5); if not sufficient, also increase the percentage of falling pellets (from 0 to +5) to arrive to the condition in Figure 3.

If the changes made to the settings do not bring the stove to the right combustion conditions in Figure 3, contact the Technical Support Centre.



**Pic. 2**

INCORRECT combustion, "spring" flame in "wood stove" style with high quantity of pellets not burning on the grate. Firstly, check the door is closed and the ash pan. Secondly, correct the pellet/air set by increasing the percentage of air (from 0 to +5); if not sufficient, also reduce the percentage of falling pellets (from 0 to -5) to arrive to the condition in Figure 3.

If the changes made to the settings do not bring the stove to the right combustion conditions in Figure 3, contact the Technical Support Centre.



**Pic. 3**

The combustion IS CORRECT, full flame yellow/white and minimum quantity of pellet in the fire pot.

The combustion is fine and no ad.

The picture 3 shows a flame done with a stove working at power P5.



### Compliance status

This manual describes the installation and operation of the Ravelli, Vittoria V, Atena V and RV 120 Touch wood pellet heater. This heaters meet the 2020 U.S. Environmental Protection Agency's wood pellet emission limits for wood heaters sold after May 15<sup>th</sup> 2015. Under specific test conditions this heater has been shown to deliver heat at rates ranging from 12900 to 37000 Btu/hr.

	Emission Rate (g/hr)	Heating Efficiency (% Overall)	1st hour Emission Rate (g/hr)	CO emission gr/hr
Vittoria V	0.6	79.25%	2.19	2.8
Atena V	0.6	79.25%	2.19	2.8
RV 120 Touch	0.6	79.25%	2.19	2.8

### Spare parts

Use original spare parts only. Do not use any substitute material. Do not wait for the components to be worn before replacing them. Replace a worn component before it is completely broken to prevent any accidents caused by the sudden breakage of components, perform the periodic maintenance checks as described in the dedicated chapter. Removal of broken or damaged components shall be only done by authorized technical service.

### Glass and gasket replacement

Use only ceramic type glass. To replace the glass the door needs to be disassembled according to the below drawing.

#### Vittoria V - Atena V - RV 120 Touch

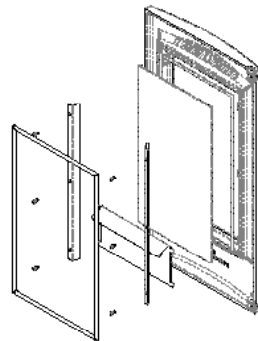

#### Ceramic glass dimensions:

272 x 510 mm (10.71" x 20.08")  
thickness 5mm (0.20")

#### Glass ribbon trectotee gasket:

8 mm x 3 mm (0.31" x 0.12")  
L1540 mm (60.63")

#### Door tricovet gasket:

diam. 10 mm (0.39")  
L1680 mm (66.14")

## SAFETY DEVICES

The stove is fitted with sophisticated safety systems so that, in the case of breakage of one of the individual parts or defects in the flue, no damage will be caused to the stove and the room in which it is installed. In any case, when a problem arises, the pellets stop falling immediately and the “ switch off ” phase is activated.

The corresponding alarm will be shown on the display. The details can be seen in chapter 9 "DESCRIPTION OF ALARMS".

## TECHNICAL FEATURES

		<b>Vittoria V</b>	<b>Atena V</b>	<b>RV 120 Touch</b>
Height	Inch	45.7	45.8	45.8
Width	Inch	20.2	21.1	21.1
Depth	Inch	22.4	22.4	22.4
Weight	Lbs	420	420	400
Diameter of smoke exit tube	Inch	3.1	3.1	3.1
Min - max hourly consumption of pellets	Lbs/h	1.8 - 5.3	1.8 - 5.3	1.8 - 5.3
Supply	V - Hz	120 - 60	120 - 60	120 - 60
Hopper capacity	Lbs	50	50	50
Efficiency *	%	79.25	79.25	79.25
Smoke temperature min - max	°F	200 - 415	200 - 415	200 - 415

\*overall heating efficiency is determined using higher heating value of the fuel.

The data shown above are indicative and not binding. Ravelli reserves the right to make any modifications for the purpose of improving the performances of the product.

### **Automatic cleaning system**

The stove is equipped with automatic brazier cleaning system. This means that there is no need to carry out daily manual cleaning of the brazier or every time the stove is lit. The automatic cleaning system is activated every time the stove is lit and after 6 hours of continuous operation. The cleaning cycle, which involves shutting down, automatic cleaning and restarting the stove, takes about 10 minutes. During this period the heating is guaranteed by the heat accumulated by the appliance itself.

Note: the times indicated are those set by default by the Manufacturer.

## **POSITIONING, ASSEMBLY AND INSTALLATION**

### ***Environment of use***

The positioning of the stove is decisive for a successful and equal heating of the room. Before deciding where to place the stove, the following must be taken into account:

- The stove must be installed on a floor with a sufficient carrying capacity. If the existing building does not meet this requisite, appropriate measures must be taken (i.e. load distribution plate).
- The combustion air cannot be obtained from a garage or from an area without ventilation or exchange of air, but from a free or external space
- The stove must not be installed in a bedroom, bathroom or shower, or where there is already another heating appliance without an autonomous air flow (chimney, stove etc.)
- A non-combustible Hearth board 6" from front of unit and 6" from the sides must be installed before unit is placed on the floor.
- Installation is better in a large and central room in the house to ensure maximum circulation of the heat;
- Connection to the main supply is recommended using a grounded outlet (if the cable supplied is not long enough to reach the nearest outlet, use an extension cord with a surge protector);
- The stove must be placed in a position that receives the necessary level of air for appropriate combustion of the pellets (at least 131.23 f<sup>3</sup>/h must be available), in accordance with installation regulation and local legislations;
- All joints for connector pipe is required to be fastened with at least three screws.
- If vented horizontally joint should be siliconed with hi-temp. silicone and screwed so they are gas tight. (RTU 500 silicone)
- the chimney connector shall not pass through an attic or roof space, closet or similar concealed space, or a floor or ceiling. Where passage through a wall, or partition of combustible construction is desired, the installation shall conform to CAN/CSA-B365.

The stove must be installed and assembled by qualified personnel.

The room must be:

- Prepared for the environmental functioning conditions
- Prepared with an adequate system of evacuation of smoke
- Have a 120V 60 Hz electricity mains supply
- Do not connect this unit to a chimney flue serving another appliance
- Use only UL Listed Type L Vent or Pellet Vent 3" in. I.D. venting system to exhaust. Do not install flue damper in the exhaust system of this unit.
- The chimney connector and each other adjoining section must be firmly attached and secured to the stove.
- Do not install the chimney directly at the outlet of the appliance. A chimney connector (flue pipe) is required unless the appliance is specifically approved for that type of installation.
- It is important to use all the specified components, do not use other components.
- "In Canada, to comply with CSA B365, Installation Code for Solid-Fuel-Burning Appliances and Equipment, any combustible covering beneath the appliance and/or within the area extending horizontally at least 450 mm (18 in) beyond the appliance on any side equipped with a door, and at least 200 mm (8 in) beyond the appliance on other sides, shall be protected by a continuous, durable, non-combustible pad that will provide ember protection. The 450 mm (18 in) ember protection required on any side with a door shall extend for the full width of the appliance plus the 200 mm (8 in) required on each side of the appliance without a door. Where an appliance is installed less than 200 mm (8 in) from a wall, the ember pad need only extend to the base of the wall. An ember pad shall not be placed on top of a carpet unless the pad is structurally supported to prevent displacement and distortion".
- Specification of the chimney as a CAN/ULC-S609 listed.

### Mobile Home Requirements

- Outside air is required
- The heater must be secured to the floor using lag bolts.
- The heater must be grounded to the chassis of the mobile home.
- Installation should be in accordance with the manufactured home.
- When outside air is required, system parts, such as vent sections, supports, spark arresters, rodent screens, etc. must be used.
- The space heater is to be connected to a type L pellet vent conforming to CAN/ULC S609 or UL641.
- Installation shall maintain an effective vapour barrier at the location where the chimney or other component penetrates to the exterior of the structure.
- Operating the space heater with open firing doors can cause serious injuries and health damages due to escaping flames or carbon monoxide generation inside the room.
- Adequate ventilation is required to avoid air starvation and icing which can determine an unhealthy indoor environment.
- Do not overfire.
- If the space heater is not correctly installed and operated it can interfere with smoke detectors.
- Where the space heater is installed in a transportable building, removal of the chimney for transportation of the building.

 Do not install in bedroom

 The structural integrity of the mobile home floor, ceiling, walls, roof must be maintained.

 Refer to HUD Requirements, CFR 3280, Part 24

 Install vent at clearances specified by the vent manufactures.

 Measure clearances to the nearest edge of the exhaust hood.

 Vent may not terminate in covered walkway or breezeway.

 If venting horizontally, check your venting specifications for distance pipe should extrude from building.

### Vent Termination Locations

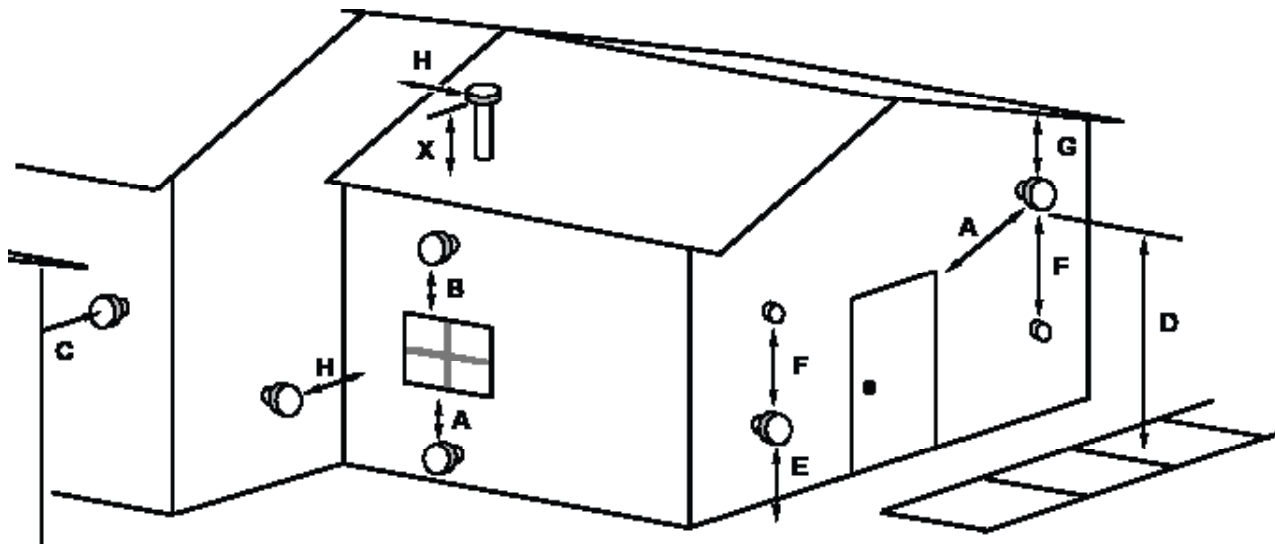

- A) Minimum 4' clearance below or beside any door or window that opens (with outside air installed, 1' below or beside)  
 Minimum 1' clearance below or beside any window that does not open.
- B) Minimum 1' clearance above any door or window that opens
- C) Minimum 2' clearance from any adjacent building
- D) Minimum 7' clearance above any grade when adjacent to public walkways
- E) Minimum 2' clearance above any grass, plants, or other combustible materials
- F) Minimum 3' clearance from any forced air intake of any other appliance
- G) Minimum 2' clearance below eaves or overhangs
- H) Minimum 1' clearance horizontally from combustible wall
- X) Must be a minimum of 2' above the roof ridge

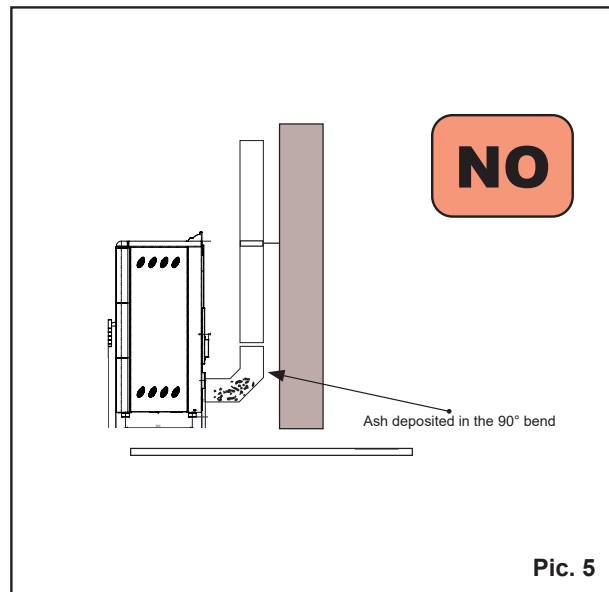
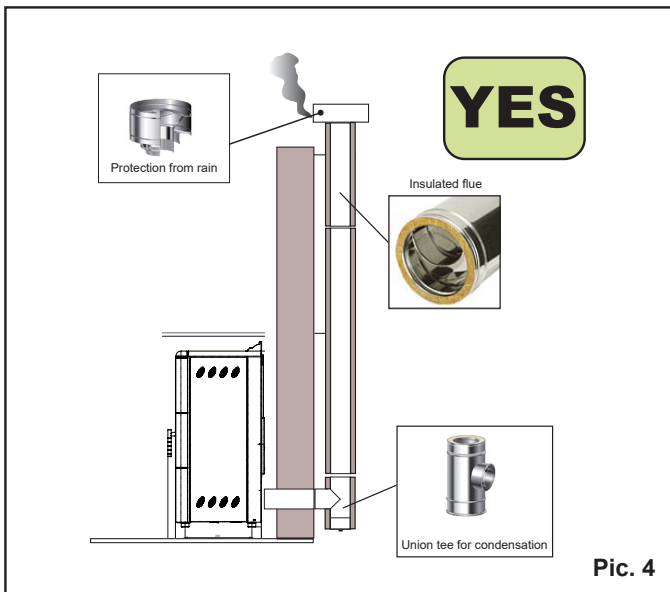
**Examples of installation**

This type of installation (see Pic. 4) requires an insulated flue, as all the smoke pipe has been installed outside the house. In the lower part of the flue, a union tee has been mounted with an inspection cap. A 90° bend should not be installed as the first initial piece as the ashes would quickly obstruct the passage of smoke, causing problems for the draught of the flue. (See Pic. 5).

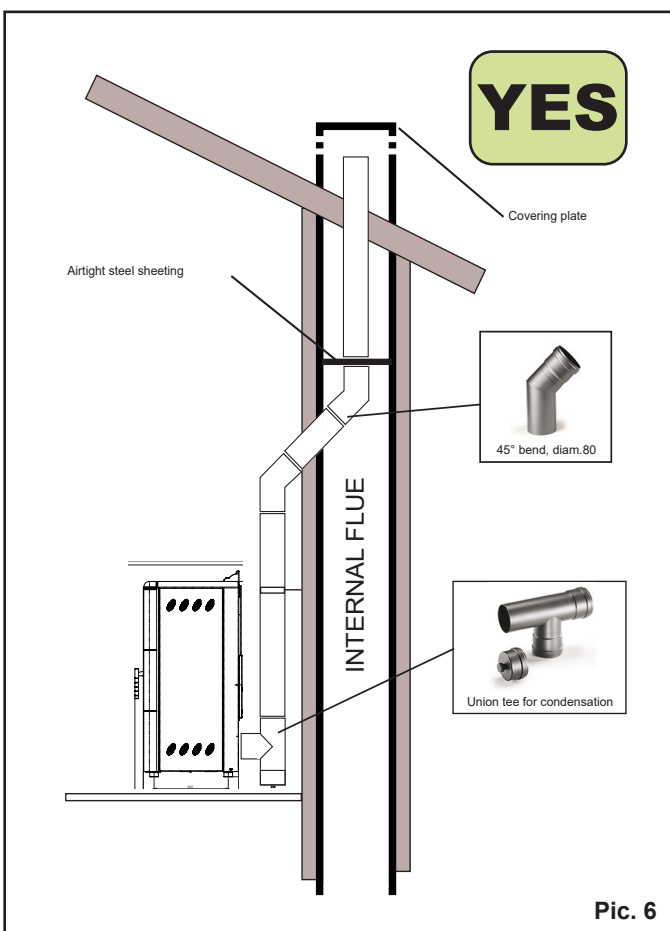

This type of installation (see Pic. 6) does not require an insulated flue as the smoke tube has been assembled partly inside the house and partly inside an existing flue.

In the lower part of the flue a union tee has been installed with a peephole cap.

A 90° bend should not be installed as the first piece, as the ash would quickly block the passage of smoke, causing problems for the draught of the flue (See Pic. 5).

Please note the use of 2 45° bends, to guarantee that the ash falls in the union tee with a peephole.

### Determining Size of Pipe to install

To determine the diameter of pipe to use (3" or 4"), you can use the following guidelines.

Fillout the installation chart (table 1), and calculate your total equivalent pipe length.

Then use the total equivalent pipe length and the altitude in the pipe selection chart. (Pic. 7) to determine if your installation requires 3" or 4" exhaust pipe.

**Table 1 - Installation chart**

Type of Pipe	# of Elbows or Feet of Pipe		Equivalent
90° Elbows/ Tee (A & G)		x	5 feet (1.5 m)
45° Elbows (C)		x	3 feet (1.0 m)
Horizontal (B & F)		x	1 feet (0.3 m)
Vertical (E)		x	0.5 feet (0.15 m)

### Sample installation chart

Type of Pipe	# of Elbows or Feet of Pipe		Equivalent	Total Equivalent
90° Elbows/ Tee (A & G)	2	x	5 feet (1.5 m)	10 feet (3.0 m)
45° Elbows (C)	1	x	3 feet (1.0 m)	3 feet (1.0 m)
Horizontal (B & F)	3	x	1 feet (0.3 m)	1 feet (1.0 m)
Vertical (E)	8	x	0.5 feet (0.15m)	1 feet (1.2 m)

**Table 2 - Sample chart for Pic. 8**

Equivalent pipe length = (10 + 3 + 1 + 1) ft = 15 ft

If the stove is installed in a place with an altitude of 2000 ft, it is possible to use either a pipe of 3" or 4", as you can see in the pipe selection chart below.

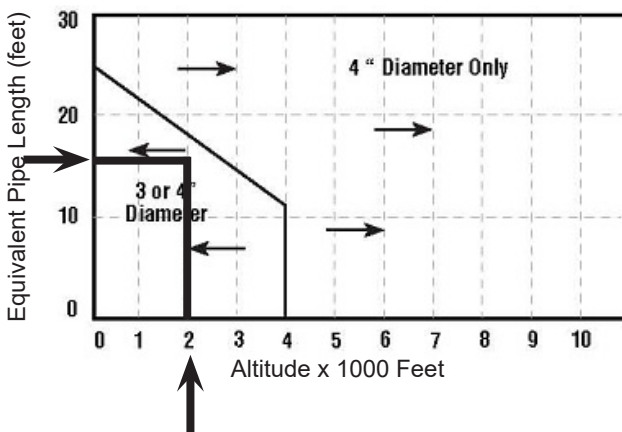
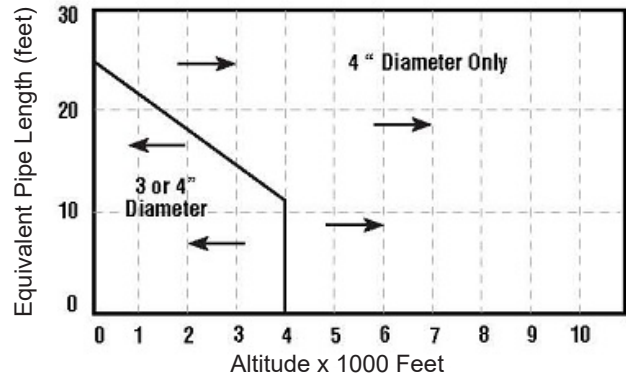
**Pic. 7 - Pipe Selection Chart**

- A- 90 Degree Elbow
- B- 1' Horizontal Pipe
- C- 45 Degree Elbow
- D- Standoff Braces
- E- 8' Vertical Pipe
- F- 2' Horizontal Pipe
- G- 90 Degree Tee
- H- Wall Thimble

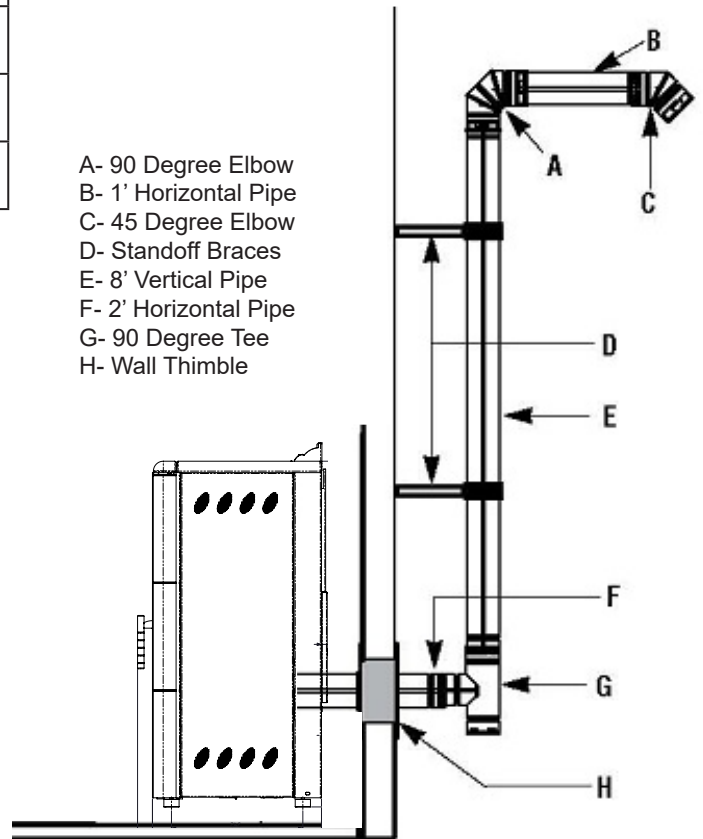
**Pic. 8 - See sample installation chart**

The vent pipe can be a minimum of 2 feet and a maximum of 45 feet long.

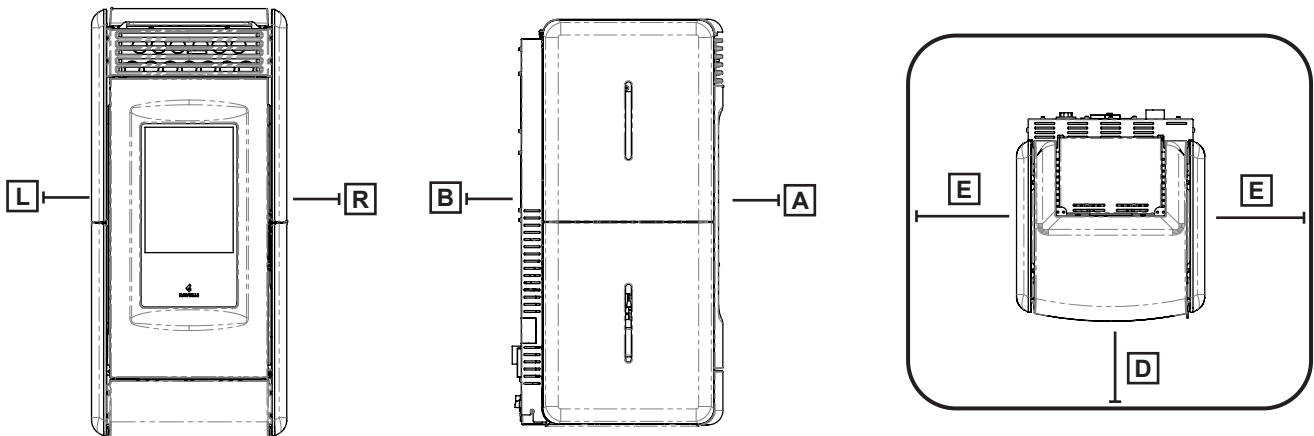
**Minimum distance from combustible material**

NOTE: Install vent at clearances specified by the vent manufactures.

Vittoria V, Atena V, RV 120 Touch				
	Unit of measurement	Corner installation	Through the wall	Without outside air inlet
Back wall to unit (B)	Inch / mm	2 / 51	2 / 51	4 / 102
Back wall to pipe	Inch / mm	2.75 / 70	N/A	1 / 25
Side wall to unit (L, R)	Inch / mm	2 / 51	2 / 51	2 / 51
Side wall to pipe	Inch / mm	2.75 / 70	11 / 280	11 / 280
Front to unit (A)	Inch / mm	40 / 1000	40 / 1000	40 / 1000
Ceiling from floor	Inch / mm	72 / 1830	72 / 1830	72 / 1830
Front (floor protection) (D)	Inch / mm	6 / 152	6 / 152	6 / 152
Side (floor protection) (E)	Inch / mm	6 / 152	6 / 152	6 / 152

Floor: combustible floor;

Floor protection: 6 in in front and sides.

N.B. The floor protection must extend under the chimney connector and 2 inches (51 mm) beyond each side.

### Standard horizontal installation configurations

1. Locate the proper position for the listed type "PL" wall thimble. Avoid cutting wall studs when installing your pipe. Use a saber saw or keyhole saw to cut the proper diameter hole through the wall to accommodate the wall thimble. Use extreme caution to avoid cutting into power lines within the wall of the home.  
The hole size will depend on the brand of pellet vent that you are using. Install the wall thimble in the hole.

The hole size will depend on the brand of pellet vent that you are using. Install the wall thimble in the hole.

2. ALL INTERLOCKING PIPE CONNECTIONS WITH-IN THE ROOM MUST BE SEALED WITH HIGH TEMPERATURE RTV AND SECURED WITH A MINIMUM OF 3 FASTENERS PER CONNECTION. Position the stove approximately 12" (305 mm) from the wall on the floor pad. Push the "PL" pipe through the wall thimble. Squeeze a bead of high temperature silicone (RTV) sealer around the end of the machined portion of the 3" (76mm) pipe connector on the back of the stove. Firmly push on a section of "PL" pipe until inner pipe liner pushes into the bead of RTV sealer.

3. Push the stove with pipe attached towards the wall (the pipe will go through the wall thimble). Do not position the back of the stove closer than 2" (51mm) from the wall.

4. Install listed type "PL" 45 degree elbow with optional rodent screen or cap (recommended) on outside end of pipe. The rodent screen should be no less than 1/2" (13 mm) mesh and may clog with soot and ash if left unattended during the burn season.

NOTE: The end of the exhaust pipe must extend a minimum of 12" (305 mm) from the outside of the building.

5. If the installation includes a source of outside combustion air; cut a separate hole through the wall for the fresh air tube. Use a galvanized or stainless steel pipe for the duct. The minimum size for the duct shall be not less than 50% of the cross sectional flue area. Connect outside air pipe to air inlet on stove.

This tube must be terminated with a 45 degree elbow or hood.

#### NOTES:

Combustion air may also be drawn from a vented crawl space under the home.

All joints for connector pipe are required to be fastened with at least three screws. If vented horizontally, joints shall be made gas-tight (air tight, sealed connection) in a manner as specified on this page (see instruction #2).

Install vent at clearances specified by the vent manufacturer.

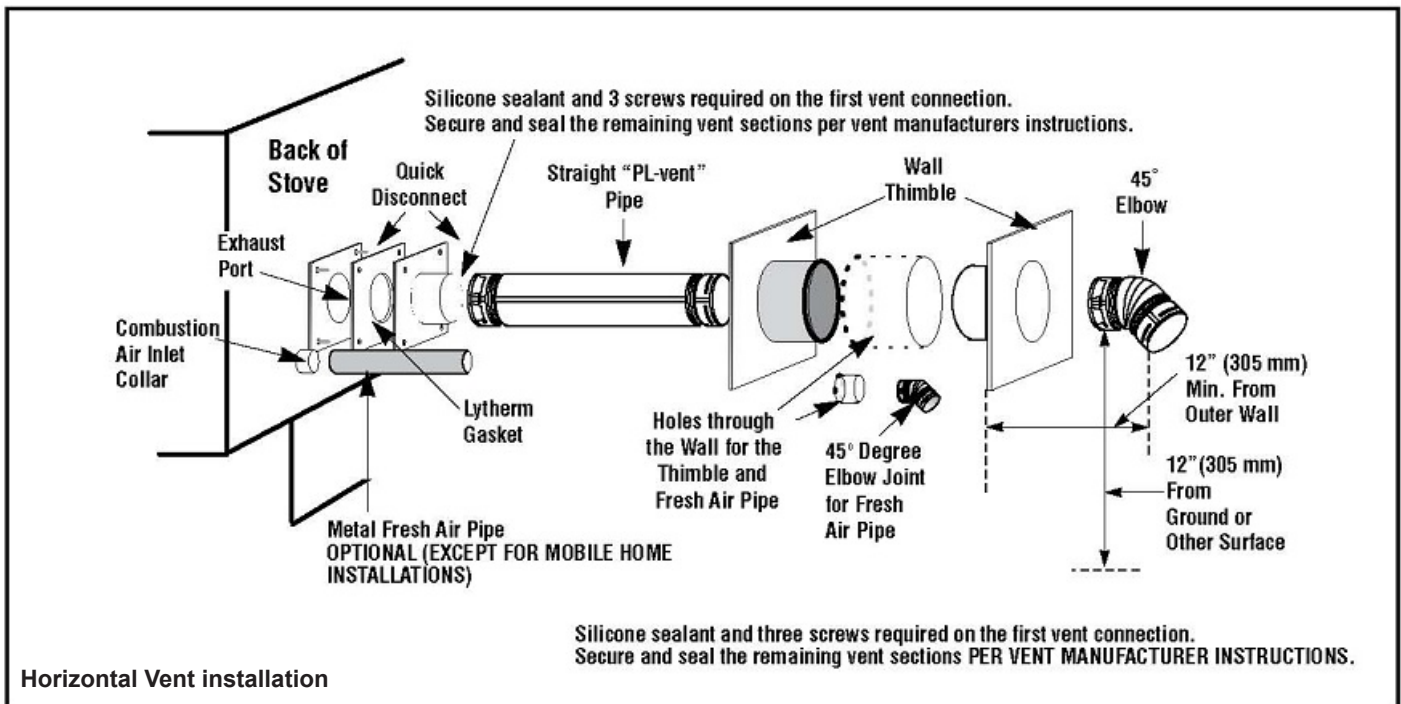



3" (75 mm) Minimum clearance between wall and pipe. If you vent to the furthest wall, the vent pipe must maintain a 3" clearance parallel to the other wall.

Top View Illustration

**YES**

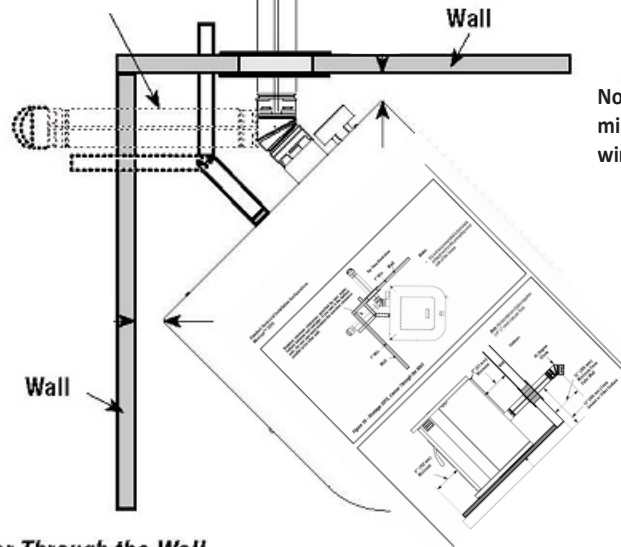

Notes: It is not recommended to terminate exhaust vent on the prevailing wind side of the house

**Figure 16 - Montage 32RS, Corner Through the Wall**

Notes: Horizontal run of pipe requires 1/4" (7mm) rise per foot.

**YES**

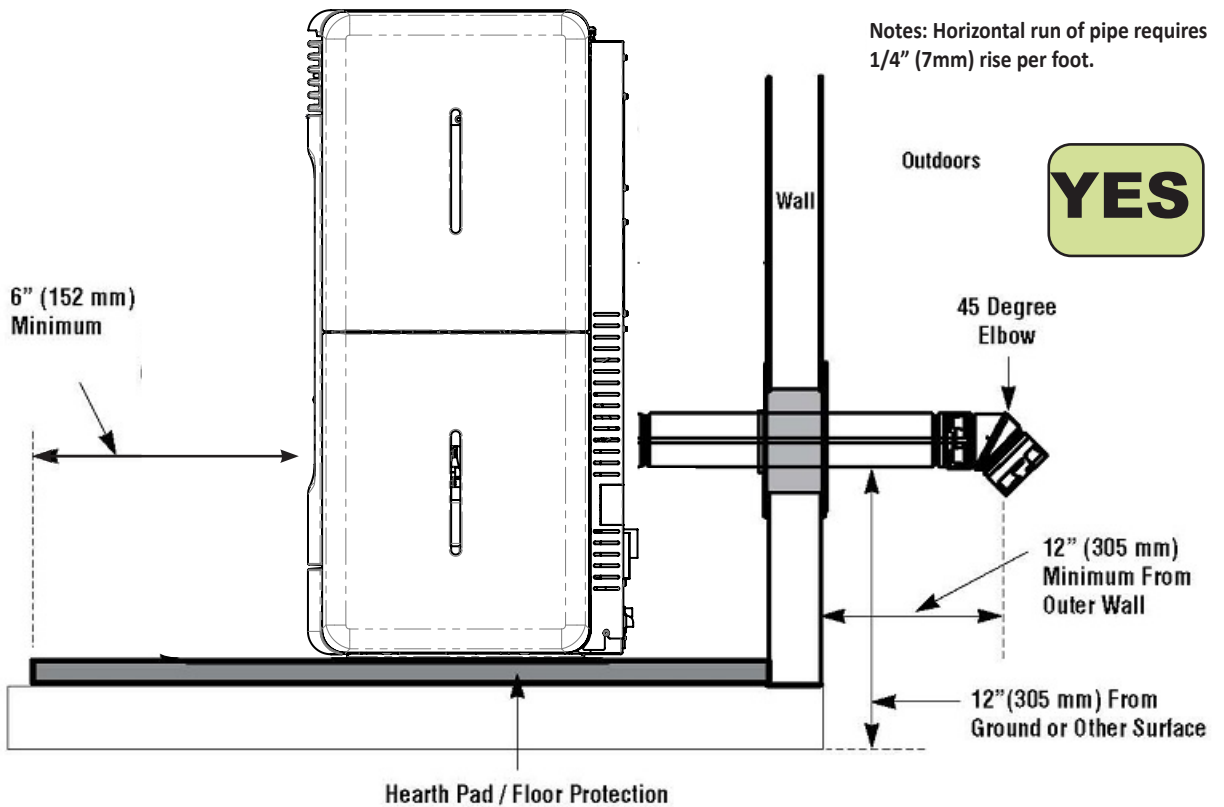

**Parallel Through the Wall**

## CONTROLS AND USE

### Control panel description

The stove is controlled by an electronic card that allows fully automatic and controlled combustion. It allows to regulate the ignition phase, the power levels and the shutdown phase, guaranteeing safe operation. On the back of the stove there is a control panel that allows you to synchronise the electronic discharge with the remote control and turn the stove on/off.

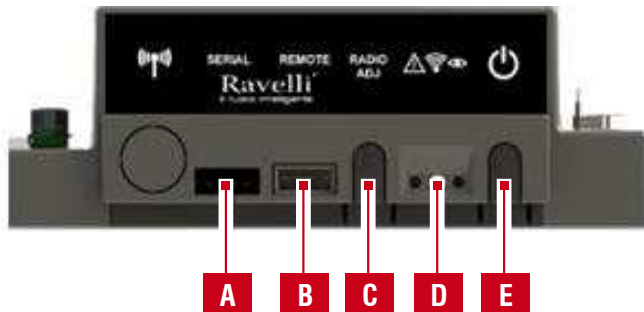

<b>A</b>	Serial socket
<b>B</b>	Remote control cable connection socket
<b>C</b>	ADJ Radio: button to connect the remote control to the card
<b>D</b>	Signaling Led Red: active allergy Yellow: Awaiting communication with the remote control Green: Stove on
<b>E</b>	Stove on/off button

### Radio touch remote control initialization

The remote control, after a first short screen showing the Ravelli logo, will list the languages available in the menu. Select the desired language with the scroll buttons and confirm your selection with the confirmation button.



In order to operate correctly, the remote control should be interfaced with the electronic board installed inside the stove. For this reason, on display appears the following message:



If the remote control is used for the first time, select YES using the selection keys and confirm with the dedicated key. On the display of the remote control appears the following:



The flashing yellow LED indicates that the circuit board is waiting to receive the signal from the remote control. By pressing the enter key on the remote control, the components start communicating with each other. A check sign on the display, accompanied by a sound signal, shows that the initialization of the remote control has been completed successfully.



In case of battery replacement, it is not necessary to perform the initialization procedure of the remote control. In this case, when the display will show the message "FIRST INSTALLATION ?", select NO and press the dial key.

### Description of the radio touch remote control

The remote control looks like the following picture:

The information below will familiarize you with the product and give you the best performance.

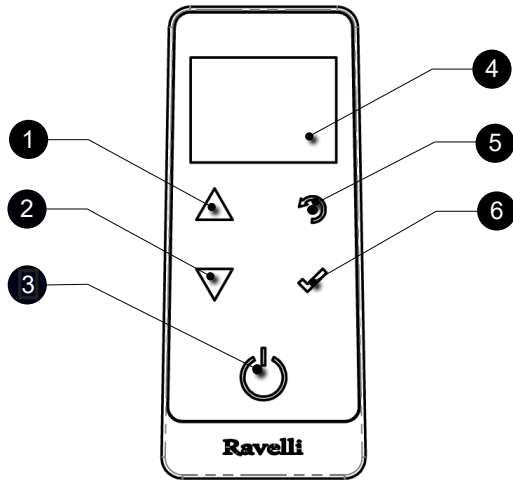

- |   |  |
|---|--|
| 1 | Increase button "UP" (selection key)   |
| 2 | Decrease key "DOWN" (selection key)    |
| 3 | ON/OFF or reset from "Sleep" mode key. |
| 4 | Display                                |
| 5 | Key for accessing the MENU and back    |
| 6 | Confirmation key                       |



In "Sleep" mode, the remote control screen is darkened, but radio communication with the stove is still active in order to reduce battery consumption.

### How to insert the batteries in the remote control:

Remove the protective cover of the battery on the back of the remote control as shown in Figure A, and insert the 3 batteries (mini pen style battery AAA 1.5V) in the housing of the remote control and observe the poles. Install the battery protective cover as shown in figure B



Figura A



Figura B

### What happens if the batteries are empty

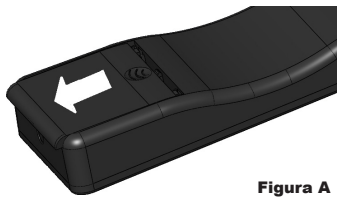
If the battery is discharged, within the "drop" is shown a symbol that indicates that the battery is empty, while maintaining active the features of your device.

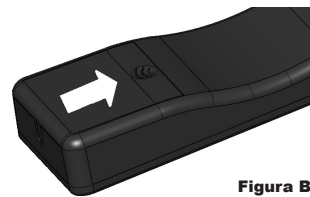

As soon as the level of the battery prevents the radio communication the remote control displays on full screen the picture of empty battery and all device functions are locked until the batteries are replaced.

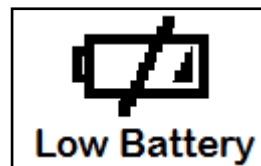

If not in use for a long time, we recommend removing the batteries from the remote control.

### Description of the display

The display of the remote control is described below (in "Home" mode):

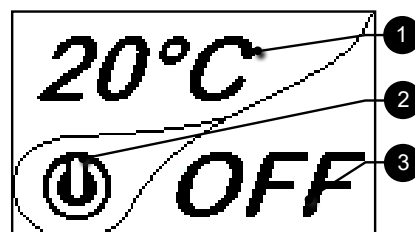



After 5 minutes of inactivity, the remote control display dims to "SLEEP" mode while maintaining the radio connection to the stove. A subsequent press of the ON/OFF key reactivates the display.



The first press of any key with active display turns on its backlight, not interpreting it as a command.

The display is subdivided into three parts:

1- It shows the current room temperature measured by the remote control. Moreover, if you press the DOWN scroll key you will display the temperature settings that can be changed using the two UP/DOWN keys. Any change made is confirmed automatically within 3 seconds from the change or by pressing the confirmation key. A sound signal indicates that the change has been confirmed.



2- Icon indicating the status of the stove (see synthetic phase diagrams).

3- In the inactive phases (combined with the second part of the display) indicates the state of the stove. In the active phases, it indicates the operating power of the stove. In addition, by pressing the DOWN scroll button, you can display the power settings, that can be edited using the two scroll keys UP/DOWN: The confirmation of any change takes place automatically within 3 seconds from the change or by pressing the confirmation key. A sound signal indicates that the change has been confirmed.



**Time and date setting**

Below are given the steps for accessing the relative menu

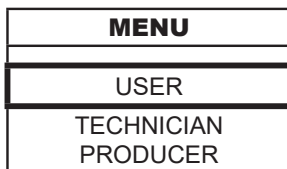

Press the key "access menu" to access the MENU page

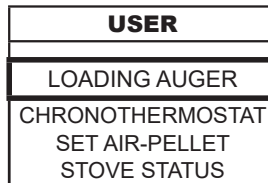

Press the key "confirm" to access the USER page

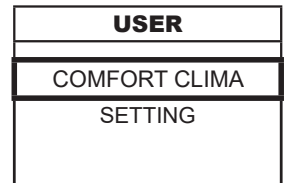

Press the key "selection" for "selection" to switch to the second page of USER MENU and select SETTINGS.

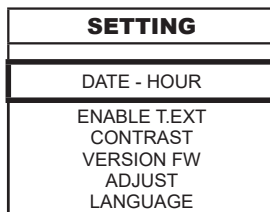

Press the key "confirm" to access the SETTINGS page



Press the key "confirm" to access the page DATE-TIME



Press the increase key to change every single value



Press the decrease key to change every single value



Press "confirm" to confirm the settings and switch to the next value.



By pressing the key "back" for several times you will display the stand-by page.

## PROCEDURES FOR USE

If the chimney catches fire you must call the fire brigade immediately.

### Checks prior to start-up

You have read and perfectly understood the contents of this instructions manual.

Before lighting the stove, you must ensure that:

- the pellet tank is full;
- the combustion chamber is clean;
- the fire door and ash drawer seals are functioning properly;
- the electrical plug is connected correctly;
- all items that could burn (instructions, various adhesive labels) have been removed;
- the brazier, if removable, is correctly positioned in its housing.

During the first hours of use the paints used for the stove finish may release an unpleasant odour. You might also smell the typical odour of metal parts subject to high temperatures. Make sure sufficient air circulation is guaranteed in the room. These unavoidable inconveniences will disappear after the first hours of operation. To reduce your discomfort to a minimum, keep the stove on for a few hours on low power and in the beginning, do not overload it, avoiding intense heating-cooling cycles

At the initial start-up, the paint finishes drying and hardens. Accordingly, to avoid ruining it, we advise you not to touch the stove's painted surfaces at this time.

### Auger loading

Before starting the stove for the first time, whenever the stove is in alarm "06 - Pellets finished", and in any case whenever the hopper has emptied completely, the initial feed screw loading is required. This phase serves to fill the pellet loading system so that, at the time of ignition, the correct pellet loading takes place in the brazier. In the event that the feed screw operations are not carried out, there may be stove ignition failures.

After loading the auger and before lighting the stove, always remember to empty the brazier and check that the brazier is clean. Never empty the brazier inside the hopper.

After each maintenance operation, make sure that the brazier is positioned correctly in its seat.

In models with self-cleaning brazier it is not necessary to remove the pellets in the brazier: the pellets loaded are sufficient for subsequent ignition.

<table border="1" style="margin: 10px auto; text-align: center; width: 150px;"> <tr><td><b>MENU</b></td></tr> <tr><td> </td></tr> <tr><td>USER</td></tr> <tr><td>TECHNICIAN</td></tr> <tr><td>PRODUCER</td></tr> </table>	<b>MENU</b>		USER	TECHNICIAN	PRODUCER	<table border="1" style="margin: 10px auto; text-align: center; width: 150px;"> <tr><td><b>USER</b></td></tr> <tr><td> </td></tr> <tr><td>LOADING AUGER</td></tr> <tr><td>CHRONOTHERMOSTAT</td></tr> <tr><td>SET AIR-PELLET</td></tr> <tr><td>STOVE STATUS</td></tr> </table>	<b>USER</b>		LOADING AUGER	CHRONOTHERMOSTAT	SET AIR-PELLET	STOVE STATUS	<table border="1" style="margin: 10px auto; text-align: center; width: 150px;"> <tr><td><b>LOADING AUGER</b></td></tr> <tr><td> </td></tr> <tr><td></td></tr> <tr><td><b>120"</b></td></tr> </table>	<b>LOADING AUGER</b>			<b>120"</b>
<b>MENU</b>																	
USER																	
TECHNICIAN																	
PRODUCER																	
<b>USER</b>																	
LOADING AUGER																	
CHRONOTHERMOSTAT																	
SET AIR-PELLET																	
STOVE STATUS																	
<b>LOADING AUGER</b>																	
<b>120"</b>																	
Press the "menu access" button to access the MENU screen.	Press the "confirm" button to access the USER screen	Press the "confirm" button to activate feed screw rotation															

### Switching the appliance on and off

From the "Home" screen, it is possible to switch the stove on and off by keeping the ON / OFF button pressed on the device for a few seconds. An acoustic signal will warn you that the appliance has switched on or off. In case it is not possible using your remote control you can switch the appliance on / off using the appropriate button on the electronic board.

Do not switch off the heater by unplugging the plug from the wall socket.

The appearance of the "SET RDS" message indicates that the initial parameter testing and calibration procedure was not carried out correctly. This indication does not imply blocking the stove (see SIGNALING POP UP section).

### Failed ignition

If the system does not detect the ignition of the flame within the preset time, operation will be blocked with the “No ignition” alarm. Before relighting the stove, check that there are pellets in the hopper, that the door and ash drawer compartment are closed, that there are no obstructions to the combustion air inlet system and above all that, in models without self-cleaning brazier, the brazier is empty, clean and correctly positioned. If the problem persists, it could be due to a technical problem (ignition plug, adjustments, etc ...), so please contact a Ravelli CAT.



The accumulation of unburned pellets in the brazier after a failed ignition must be removed before proceeding with a new ignition.



The brazier could be very hot: danger of burns!



Never empty the brazier inside the hopper.

### Setting operating temperature and power:

Set the two values following the indications given in the chapter “Description of the display”

## OPERATING PHASES OF THE APPLIANCE

### Sequence of ignition phases

IGNITION - initial pellet loading phase;

FLAME LIGHT - flame stabilization phase and reduction of combustibile inside the brazier;



WORK - operation phase described in the dedicated chapter;



### Modulation

During the work phase, the appliance should reach the room temperature set; when this condition is met, the stove switches to MODULATION mode in which fuel consumption is minimum.



If you wish to detect the ambient temperature by means of an external thermostat (optional), this must be connected to the appropriate connector on the rear side of the stove; and you will have to activate the reading in “SETTINGS - ENABLE THERMOSTAT.” On display appears the writing TON / TOFF based on thermostat request.



Connect an external thermostat with a simple dry contact, therefore, not powered, moreover, we recommend you use a thermostat with a minimum offset of 3°C if you intend to use the comfort clima function.

### Description of menu functions



Press the key to access the MENU page

<b>MENU</b>
USER
TECHNICIAN PRODUCER



The TECHNICIAN and PRODUCER menus are password protected. Changing parameters within these menus could compromise the operation and safety of the stove. In this case the warranty will be invalidated.

### Chronothermostat

With the Chrono-thermostat function you can program the automatic switch ON/OFF of the stove for each day of the week for each day of the week in 4 independent time intervals (SET CHRONO 1-2-3-4). Below are given the steps for accessing the relative menu starting from "Home" mode.

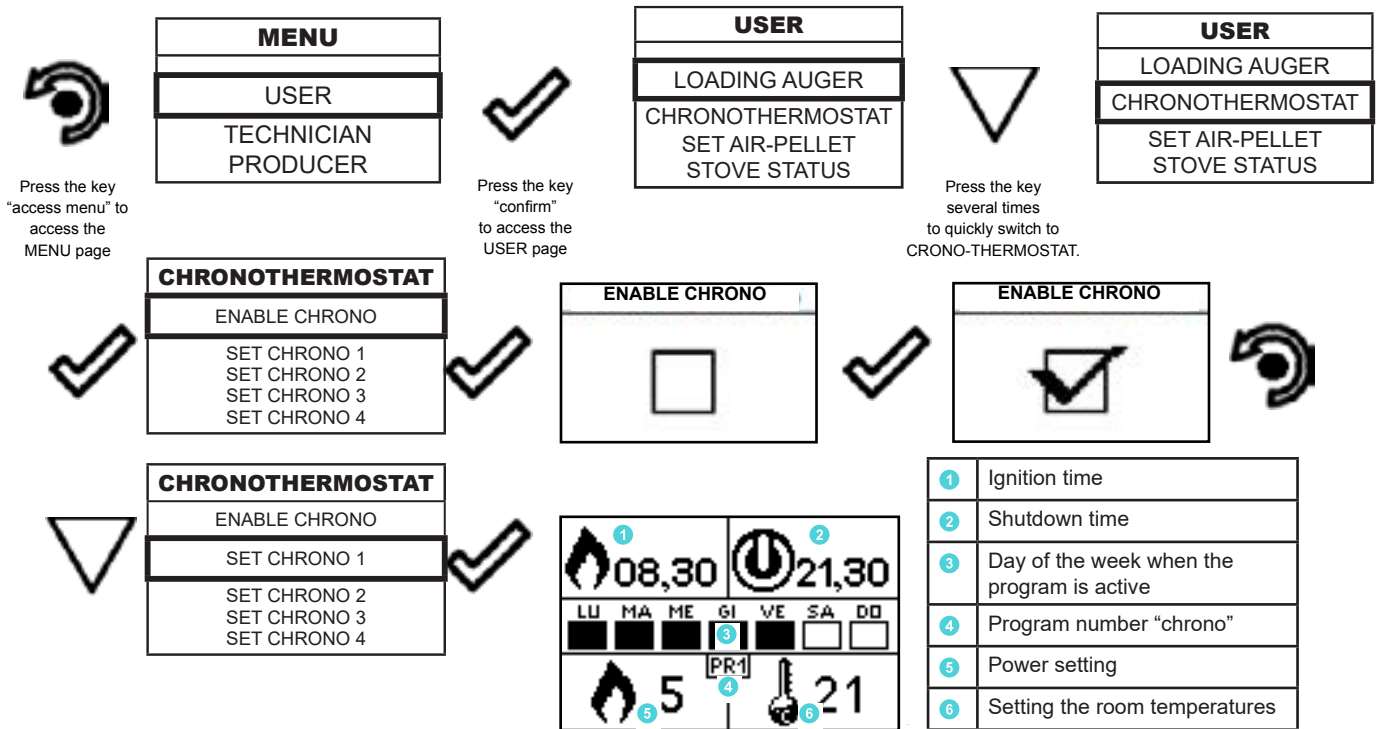

The exit key shows the CHRONO menu to set other variables related to the menu functions.

To exit the page and return to "Home" page, press the button repeatedly.

### Set air - pellet

The setting of the PELLET-FLOW mixture allows to adjust the combustion by varying the quantity of pellets loaded in the brazier and/or the quantity of air. In fact, by its nature, pellets vary in grain size and composition: even bags of pellets of the same brand can have different characteristics.

If combustion is not optimal, vary the flow parameter to adjust the combustion air. If air regulation alone is not sufficient, it may also be necessary to modify the pellet parameter.

**!** Combustion regulation is an operation that requires a lot of experience. We recommend that you contact an Authorised Service Centre to calibrate the stove appropriately.

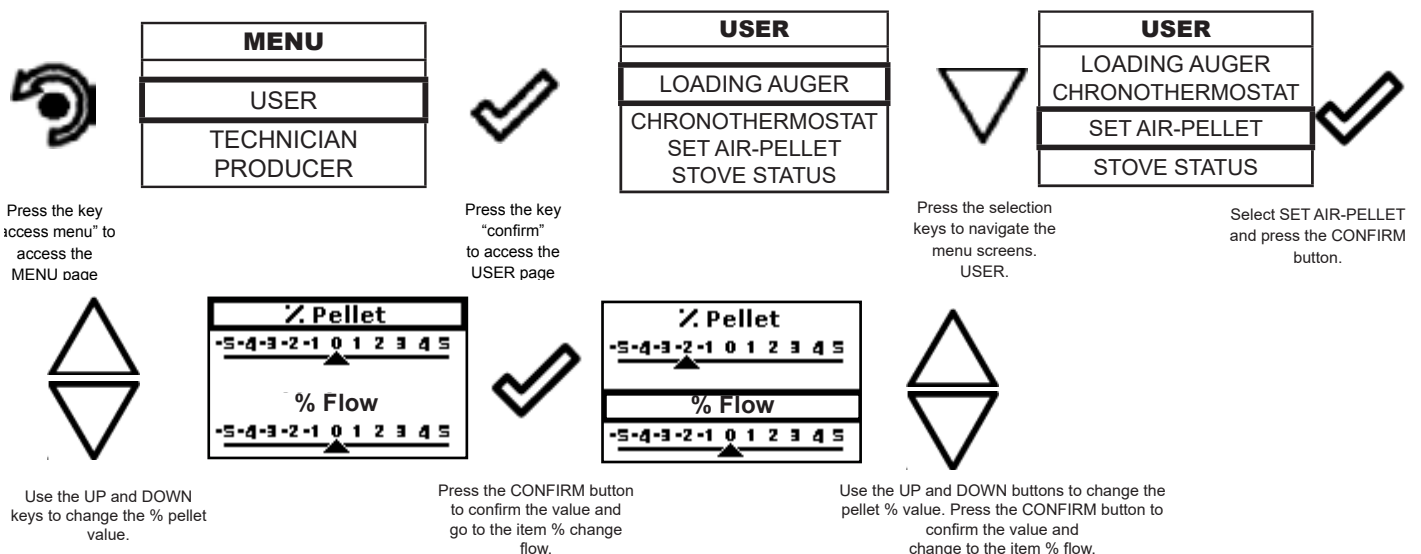

To exit the screen and return to the home screen, press the key repeatedly.

**Stove status**

Below are given the steps for accessing the relative menu starting from "Home" mode.

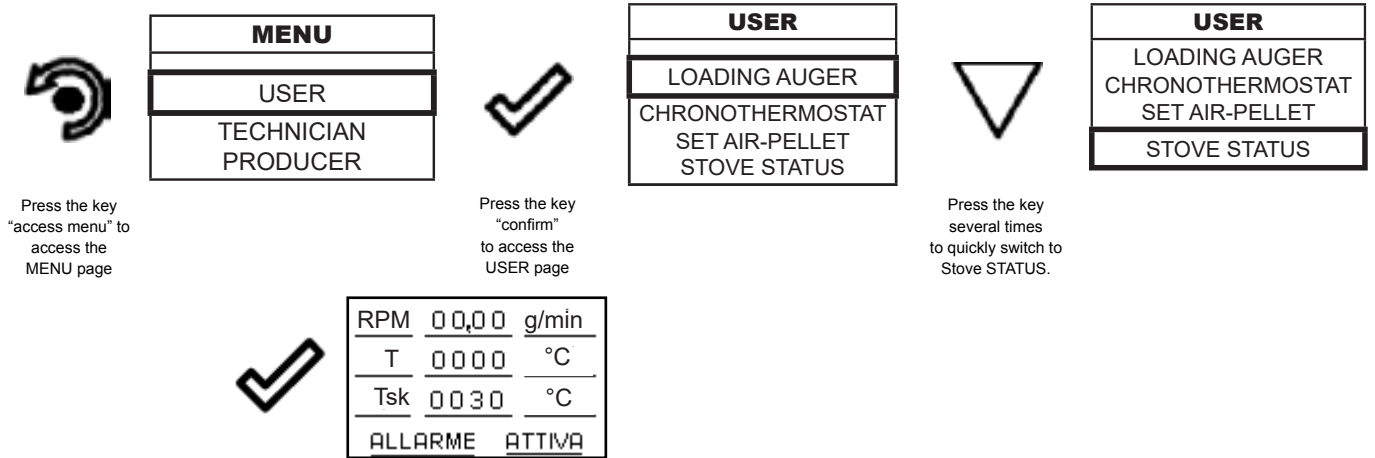

In this mode you can check the proper operation of the most important parameters of the appliance. Here is a list of real data of the stove useful for service during inspection.

- RDS current reading RDS (m/s)
- RPM current smoke extractor speed (rpm)
- T fumes temperature (°C)
- Indication of stove status
- SET set value RDS (m/s)
- Df cold probe temperature RDS (°C)
- Sk: electronic board temperature (°C)

To exit the STOVE STATUS screen and return to the Home screen, press the key repeatedly.

**Comfort clima**

The activation of this function enables the stove to reduce pellet consumption by activating the modulation phases, after the desired temperature has been reached. Subsequently, the stove checks that the temperature is maintained steady for a preset time (DELAY SWITCH OFF). If this condition is met, it automatically switches off, and on display appears the writing ECO. The stove turns on again when the temperature drops below the set threshold (DELTA RESTART).

Below are given the steps for accessing the relative menu.

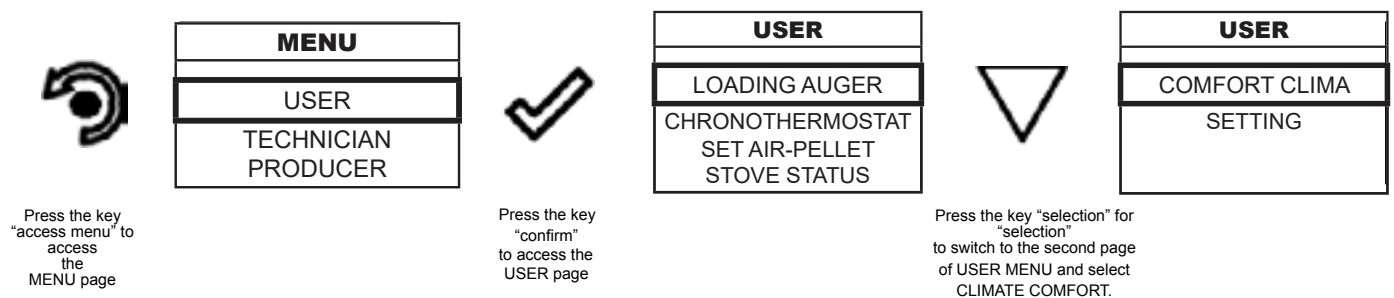

Once you have accessed the Comfort Clima menu, it is possible to operate on the 3 types of settings dedicated to the function:

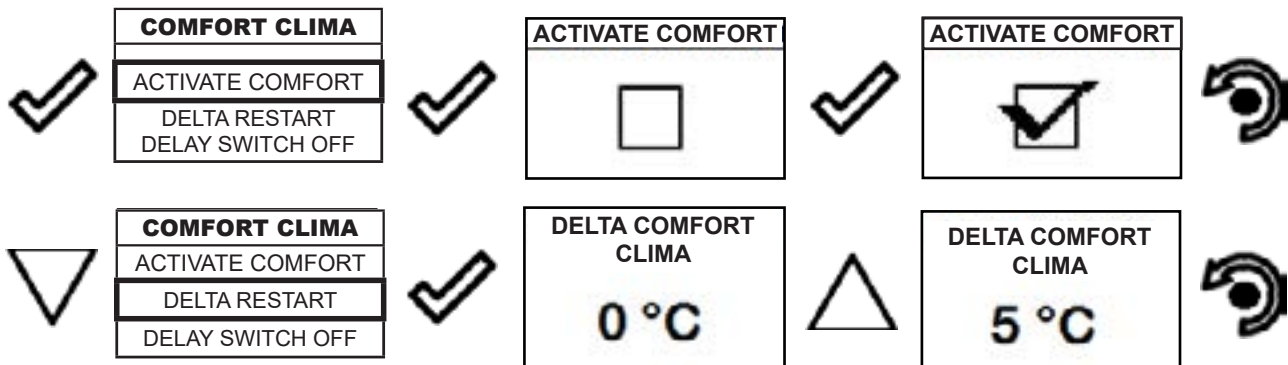



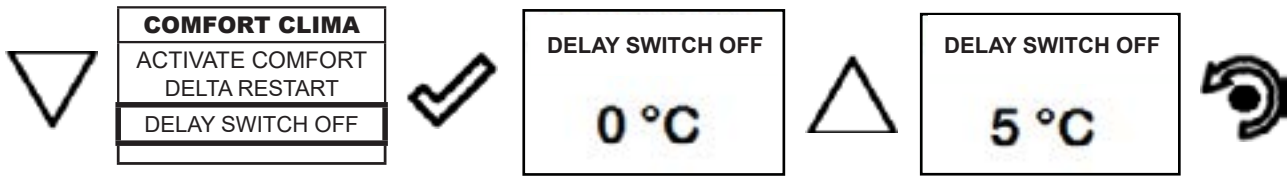

The first setting allows the activation of the COMFORT CLIMA function. This function is intended to ensure that the room temperature set is maintained steady upon setting the maximum period of "X" minutes (SWITCH-OFF DELTA Y: 5 MIN) before switching to ECO STOP phase. The STOVE maintains this state until the temperature drops below the set value (DELTA COMFORT CLIMA: 5°C). For example, with the room temperature at 21 °C, the stove switches off when this temperature is reached and restarts when the temperature reaches 16°C (21°C - 5°C). You can also activate the function using an external thermostat, keeping in mind that this does not include the value of hysteresis.

### Setting

Below are the steps to follow, starting from the Home screen, to access the Home menu.

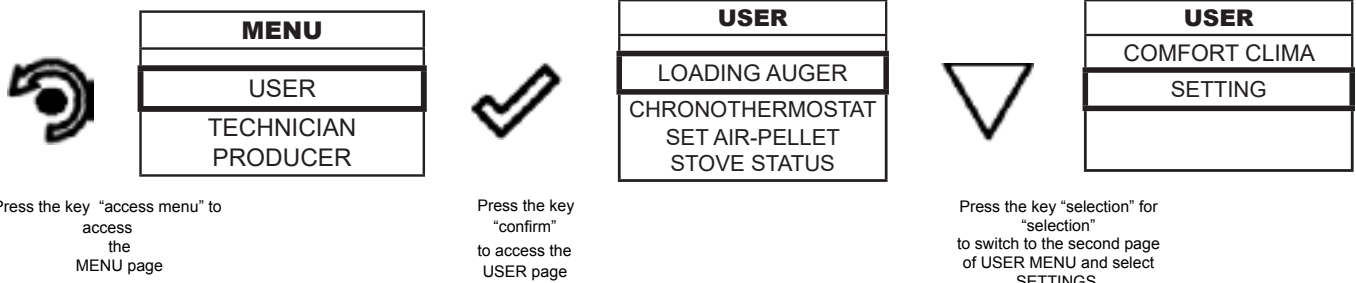

Press the key "access menu" to access the MENU page

Press the key "confirm" to access the USER page

Press the key "selection" for "selection" to switch to the second page of USER MENU and select SETTINGS.

After following the above procedure

### Settings > Enable thermostat

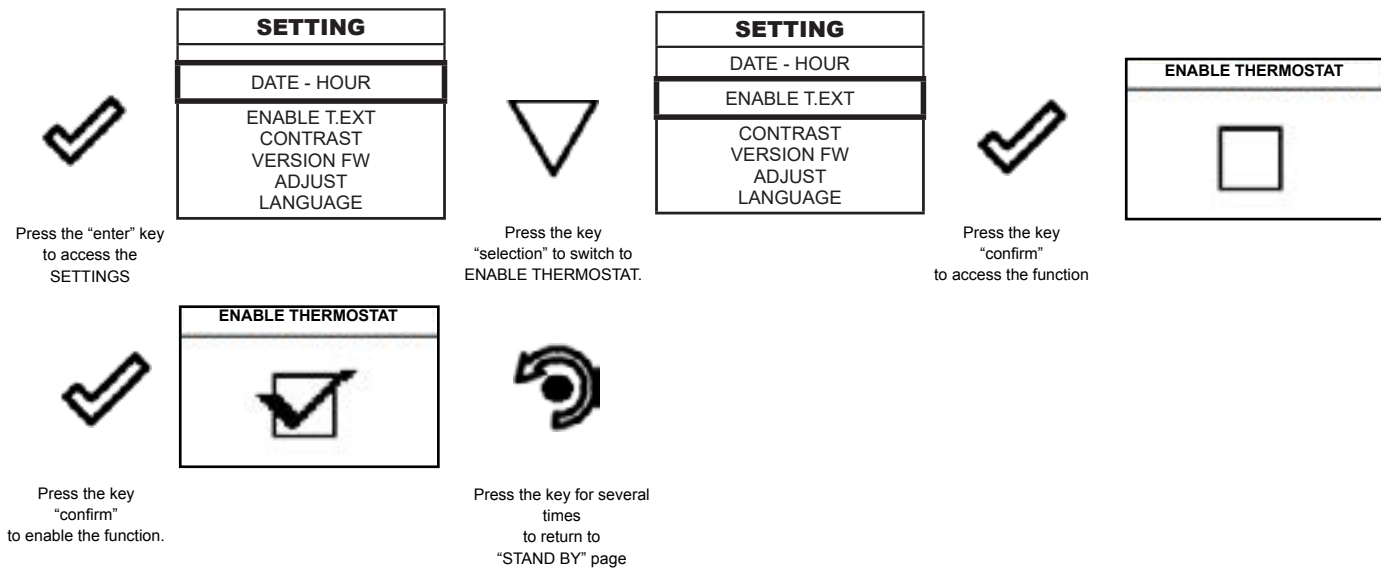

Press the "enter" key to access the SETTINGS

Press the key "selection" to switch to ENABLE THERMOSTAT.

Press the key "confirm" to access the function

Press the key "confirm" to enable the function.

Press the key for several times to return to "STAND BY" page



In "Home" mode, instead of room temperature measured and settable, appears the line T ON if the room in which the thermostat is installed has not reached the temperature requested or the writing T OFF if the temperature in the room is reached.

### Settings > Contrast

With this function you can change the contrast setting to improve the display of your remote control. The contrast setting to improve the display of the remote control display.

Press the key "confirm" to access the SETUP SETTINGS

SETTING
DATE - HOUR
ENABLE T.EXT
CONTRAST
VERSION FW
ADJUST
LANGUAGE

Press the key "selection" to switch to the function CONTRAST.

SETTING
DATE - HOUR
ENABLE T.EXT
CONTRAST
VERSION FW
ADJUST
LANGUAGE

Press the key "confirm" to access the function

CONTRAST
50

Use the UP/DOWN keys to change contrast setting and obtain a better visualisation of the information shown on the remote control set. The value can vary from 0 to 100. 50 with respect to the standard value.

By pressing the following key you will confirm of data and switch to the page within SETTINGS menu.

### Settings > Firmware version

Press the "enter" key to access the SETTINGS

SETTING
DATE - HOUR
ENABLE T.EXT
CONTRAST
VERSION FW
ADJUST
LANGUAGE

Press the key "selection" to switch to CONTRAST.

SETTING
DATE - HOUR
ENABLE T.EXT
CONTRAST
VERSION FW
ADJUST
LANGUAGE

Press the key "confirm" to access the function

FIRMWARE
AIR_TOUCH_MB01.00
SNELLINA
AIR_TOUCH_UI01.00

By pressing the button you will confirm the data and switch to the page within the SETTINGS menu.

### Settings > Adjust

The adjust function allows to modify the value read by the room probe inside the remote control, increasing or decreasing it by the set value (offset).

Make this adjustment carefully and only after having checked deviations from the actual room temperature with a reliable instrument!

Press the key "confirm" to access the SETUP SETTINGS

SETTING
DATE - HOUR
ENABLE T.EXT
CONTRAST
VERSION FW
ADJUST
LANGUAGE

Press the key "selection" to switch to the function VERSION FW.

SETTING
DATE - HOUR
ENABLE T.EXT
CONTRAST
VERSION FW
ADJUST
LANGUAGE

Press the key "confirm" to access the function

ADJUST
0° C

UP" and "DOWN" buttons The value can vary from -10°C to 10°C. The standard value is 0°C.











Pressing the following key allows you to confirm the data and move to the screen within the SETTINGS menu.

### Settings > Language

To access the next setting, follow the steps given above or simply remove and replace the batteries.

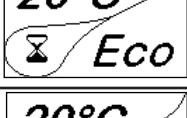
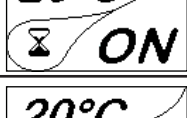
The device resets and prompts you again to select the language you want to set.

**Stove phase general layout**

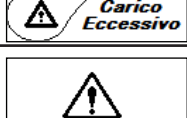
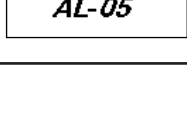
	PHASE	DESCRIPTION
	FINAL CLEANING	The stove is in the switch off phase and the cooling phase has not been completed yet.
	IGNITION	The heater pre-heating phase has started and the pellets start to fall into the grate.
	FLAME LIGHT	The pellets ignite and take advantage of the heat in the intake air that passes through the incandescent heater tube.
	WORK	The stove has completed the switch on phase and runs at maximum set power
	MODULATION	The room temperature set has been reached.
	FIRE POT CLEANING	Fire pot cleaning phase is active (periodic function).
	ECO STOP	With Climate Comfort active, the stove switches to automatic switch-off mode when the room temperature set is reached (see the dedicated section).
	WAITING START / RESTART	Switch-on is requested but with the stove in cooling phase; once this condition is met, it restarts automatically.
	IGNITION RESTART	The HOT restart phase is activated. Functioning is similar to the SWITCH ON phase
	HOT SMOKES	The maximum fume temperature threshold has been reached. To facilitate cooling, the stove brings the capacity to a minimum with ventilation at power level 5, leading to a decrease in fume temperature.
	OFF	The stove is off
	WAIT FOR PELLETS OUT OF	When the switch-on request from ECO-STOP mode coincides with an automatic switch-off condition (from the TIMER), the stove turns on ensuring total cleaning of the fire pot before switching to FINAL CLEANING.
	AUGER OVERFLOW	CONDITION: when the pellet setting (set pellets +5) is near the continuous load condition. SOLUTION: Set the value back to 0.
	ALARM (generic)	The stove is in alarm state; refer to the troubleshooting chapter.

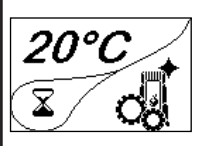
	<b>ANOMALY (general)</b>	The stove has detected an anomaly; refer to the troubleshooting chapter. By pressing the confirmation key, the problem is described.
	<b>AUTOMATIC CLEANING SYSTEM ACTIVE</b>	For models with automatic cleaning system it indicates the operating state of the same.

**Warning Pop -Up**

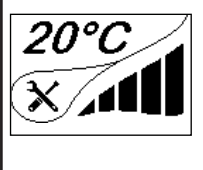
	ANOMALY	DESCRIPTION
	<b>SERVICE REQUEST</b>	The threshold value of set work hours has been reached. The symbol displayed remains active throughout the work phase. Non-routine maintenance is required on the stove.

**Alarms (table with reference codes)**

	TITLE	REASON	SOLUTION
<b>AL 01</b>	<b>BLACK OUT</b>	No voltage during work phase	Press the switch off key and switch on the stove again If the problem persists, contact the Support Service
		<b>AL 02</b>	<b>SMOKE PROBE FAILURE</b>
The smoke probe is disconnected from the electronic board	Contact the Support Service		
<b>AL 03</b>	<b>OVERTEMP. SMOKE</b>	Combustion in the fire pot is not optimal due to clogging or obstructions of internal stove ducts inside the stove	Switch off the stove, clean the fire pot and the tube bundle and adjust the combustion setting the Pellet/Air values Contact the Support Service
		If the problem persists, contact the Support Service	
		<b>AL 04</b>	<b>FAN BROKEN</b>
No power to fume extractor.	Contact the Support Service		
The fume extractor is blocked.	Contact the Support Service		
<b>AL 05</b>	<b>NO IGNITION</b>	The pellet tank is empty.	Check for the presence of pellets in the container. Top up, if necessary.
		Pellet calibration and suction during switch on phase is incorrect.	Contact the Support Service
		The ignition coil is faulty or positioned incorrectly	Contact the Support Service
<b>AL 06</b>	<b>NO PELLETS</b>	The pellet tank is empty.	Check for the presence of pellets in the container. Top up, if necessary.
		The gear motor is not loading pellets.	Empty the tank to see if there are any objects inside that may prevent proper operation of the auger.
		Not enough pellets loaded	Regulate pellets setting from "SET AIR/PELLETS"
		If the problem persists, contact the Support Service	
<b>AL 07</b>	<b>THERMAL RESET</b>	The manual or automatic reset thermostat connected to the hopper has been triggered / Door, drawer or pellet door remained open	Wait for the stove to cool, reset the thermostat (if with manual reset) by pressing the button on the back of the stove
		Combustion in the fire pot is not optimal due to clogging or obstructions of internal stove ducts inside the stove	Switch off the stove, clean the fire pot and the tube bundle and adjust the combustion setting the Pellet/Air values
		Contact the Support Service	

<b>AL 08</b>	<b>DEPRESSION</b>	The flue is blocked.	Check the flue is free and clean
		The vacuum meter is faulty.	Check the mains voltage.
<b>AL 12</b>	<b>FUME EXHAUST SYSTEM</b>	The fume exhaust system has a loss of performance due to fan obstruction or voltage drop.	Check the mains voltage.
<b>AL 14</b>	<b>AUGER PHASE</b>	No cable connection to power the gear motor	Check the mains voltage.
<b>AL 15</b>	<b>AUGER TRIAC</b>	An internal part of the electronic board that controls the pellet auger is faulty.	Check the flue is free and clean
		Possible voltage drops or incorrect input voltage	Check the mains voltage.
<b>AL 19</b>	<b>CLEANER FAILURE</b>	The cleaner did not complete the movement and is not in the correct position	Reset the alarm and wait for the stove to switch to SHUTDOWN mode. Cut off and power again, the system reactivates the cleaner searching the correct position again.
			If the problem persists, contact the Support Service

**Thermal alarm with reset**

In the case of alarm 07 THERMAL BREAKER below shows the location where to operate to reset the thermal switch with manual reset.

- 1) By pressing the button OK on the display the alarm can be reset.
- 2) Unscrew the protection cap and press the button to reset the thermostat alarm.
- 3) Try and repeat lighting after the cooling phase.

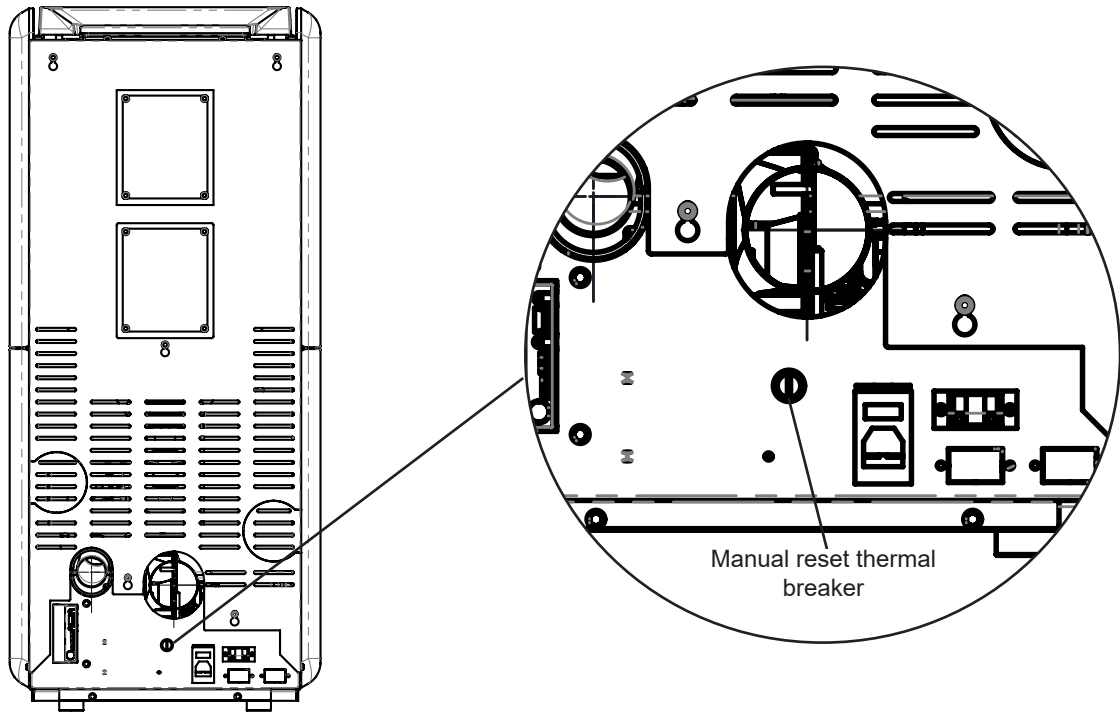

**ELECTRICAL WIRING DIAGRAM**

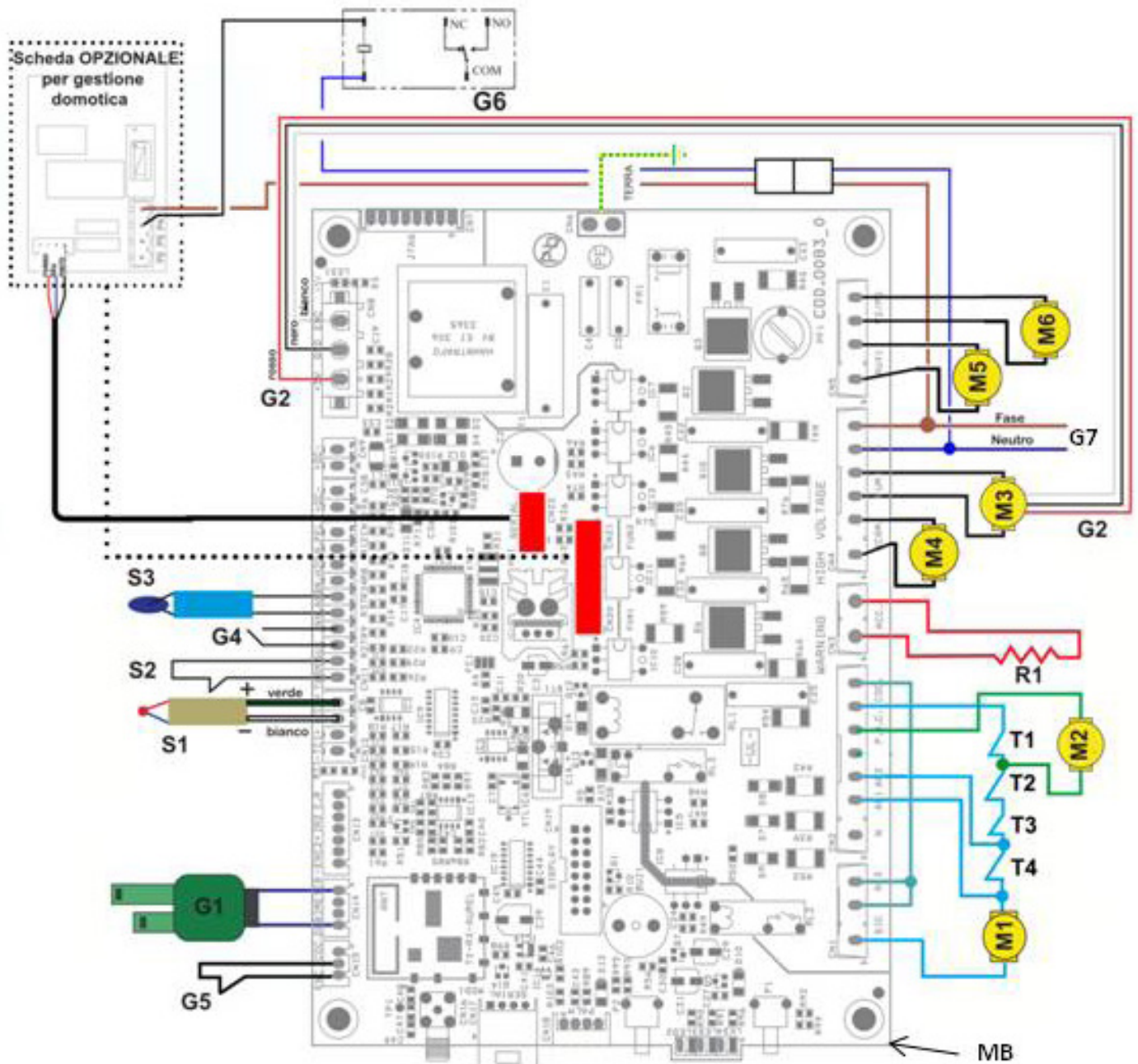

**LEGEND:**

MB- Motherboard  
 T1- Fire door contact  
 T2- Pellet hopper contact  
 T3- Pellet thermal safety  
 T4- Pressure switch

M1- Gearmotor  
 M2- Automatic cleaner  
 M3- Flue gas fan  
 M4- Front room fan  
 M5- Rear right room fan  
 (only for ducted stoves)  
 M6- Rear left room fan  
 (only for ducted stoves)

R1- Igniter  
 S1- Flame probe  
 S2- External thermostat  
 S3- Room probe (opt)

G2- Encoder reading revolutions suction  
 G3- RADIO Touch handheld remote control  
 G4- Automatic cleaner stroke counter  
 G5- Home automation management contact  
 G6- GAS ignition contact -  
 Home automation output alarm signalling (TRF 39)  
 G7- Power cord plug: main switch



**G3**

## MAINTENANCE



Cleaning should be provided by the user



This wood heater needs periodic inspection and repair for proper operation. It is against federal regulations to operate this wood heater in a manner inconsistent with operating instructions in this manual.

Before any cleaning operation on the stove, implement the following precautions:

- switch off the stove and disconnect the power cord with the stove in "Switched OFF" state;
- make sure all the parts of the stove are cold;
- make sure the ash is completely cooled.



Please read carefully the following instructions to perform proper cleaning. Failure to comply with these instructions may lead to malfunctions of the stove.

Before carrying out any maintenance operation on the stove, please take the following precautions:

- Make sure that all the parts of the stove are cold
- Make sure that the ashes are completely extinguished
- Make sure that the general switch is in the zero position (off)
- Make sure that the plug is disconnected from the socket, thus avoiding accidental contacts.



Please follow the instructions for cleaning shown below carefully! Failure to observe them may lead to problems in the functioning of the stove AND FIRE HAZARD.

### Cleaning the surfaces

To clean the surfaces on the painted metal parts, use a wet cloth in water or at the most, water and soap.



The use of aggressive detergents or diluents can damage the surfaces of the stove.

### Cleaning the FIREX 600



All Ravelli products have a combustion chamber made with FIREX 600, a material based on vermiculite, the result of research and development by Ravelli. The main features of FIREX 600 are resistant to heat, its lightness and excellent insulating capacities, improving the combustion and performance of the stove.

During combustion, FIREX 600 turns white, due to an effect called PYROLYSIS, making the flame clear and shining. If the combustion is regulated in an optimal way, the FIREX 600 interior always remains clean and white.

The condition of FIREX 600 is therefore a thermometer to understand whether the combustion is good or not.

FIREX 600 LIGHT – GOOD COMBUSTION

FIREX 600 DARK – POOR COMBUSTION

Firex 600 does not require special maintenance, it only has to be dusted with a soft brush to remove the ash that is deposited during combustion.

Abrasive sponges to clean to most resistant waste should not be used as they could compromise the thickness of the FIREX600 panel, creating critical points of breakage.

The tube of the vacuum cleaner should not be used in direct contact with FIREX 600.

Wet cloths should not be used to clean FIREX 600.

FIREX 600 is resistant to heat but not to knocks; handle with care if moved.

FIREX 600 may show a slight abrasion after a few hours of functioning, this is perfectly normal as the flame creates microgrooves in the panel without compromising it.

The duration of FIREX 600 depends only on how maintenance is carried out.

The pellet stove is a generator of heat with a solid fuel and as such requires servicing by qualified personnel at least once a year at the start of the season. This maintenance has the purpose of ascertaining and ensuring the perfect efficiency of all the components. We recommend you draw up an annual contract for maintenance of the product with your installer/dealer.



## **WARRANTY**

Read the warranty conditions contained below.

### **Warranty conditions**

The warranty for the Customer is acknowledged by the Dealer under the terms of law.

The Dealer acknowledges the warranty only if the product has not been tampered with and only if it has been installed in accordance with the Manufacturer's instructions.

The limited warranty covers manufacturing material defects, as long as the product has not broken due to an incorrect use, negligence, incorrect connection, tampering, installation errors.

The warranty becomes null and void even if only one requirement in this manual is not complied with.

The following are not covered by warranty:

- the combustion chamber refractory stones;
- the door glass;
- the gaskets;
- the paint job;
- the stainless steel or cast iron fire pot;
- the electric resistance;
- the Majolica cladding;
- the aesthetic parts;
- any damages caused by unsuitable installation and/or use of the product and/or shortcomings on the part of the customer.

The use of poor quality pellet or any other unauthorised fuel may damage the product's components, cause its warranty to be voided and as a result eliminate the connected manufacturer liability.

It is therefore recommended to use good quality pellet that fulfils the requirements listed in the dedicated chapter.

All damages caused by transportation are not recognised, for this reason it is recommended to carefully check goods upon receipt, immediately warning the reseller of any damage.

### **Registration of warranty**



To activate the warranty, it is necessary to register the product on the Guarantee Portal on the website [www.ravelligroup.it](http://www.ravelligroup.it), by entering your data and the purchase receipt.

### **Info and problems**

Dealers authorised by Ravelli use a trained Technical Service Centre network to meet the Customer's requirements. For any information or request for assistance, please contact your Dealer or the Technical Service Centre.







**Aico S.p.A.**

**Headquarter**

Via Consorzio Agrario, 3 - 25032  
Chiari (BS) - Italy

**Research and Development Centre**

Viale del commercio 12/a - 37135  
Verona (VR) - Italy

T. + 39 030 7402939  
info@ravelligroup.it

FB Ravellifuocointelligente  
IG ravellistufe

[www.ravelligroup.it](http://www.ravelligroup.it)

Aico S.p.A. does not assume any responsibility for any errors in this booklet and considers itself free to make any variations to the features of its products and to the present manual without notice.